

Traditional Church Lighting





Traditional church lighting

Comfortable, glare-free illumination. Period design adapted to architectural style. Ease of maintenance and durable construction. These are the benefits of Manning Traditional church lighting.

Different architectural styles and different denominations require different types of lighting. Most Manning Traditional fixtures offer flexibility in lamping in the direct, indirect and diffuse elements of each unit. By wiring each of these elements on a separate circuit, different lighting effects are possible with the lamping selected. The R40 and R52 reflector flood lamps featured in this catalog are available from 150 to 750 watts and are used as downlights, providing direct illumination to the pews below. Used in an uplight position, the lamps provide comfortable indirect light, and also serve to illuminate the ceiling, accenting architectural details and making the space "feel" brighter. Interior incandescent or fluorescent lamps provide diffused light through the acrylic cylinder or panels. With these different options available, any proportion of direct, indirect, or diffused light can be used to suit any requirement.



Energy saving lamping

Great strides have been made in the development of higher efficiency lamp sources since the first Manning Traditional catalog was printed in the 1950s.

Fluorescent and metal halide lamps produce higher lumen output per watt of energy and also give longer lamp life. These fixtures are more costly initially, but save money over time due to lower energy use and reduced maintenance costs.

(Incandescent lamps shown in this catalog have a typical life of 2000 hours. Fluorescent lamps have a life of up to 20,000 hours.)

All units in this catalog are available with energy saving lamping. Please contact your Manning Representative for specifications and quotation.

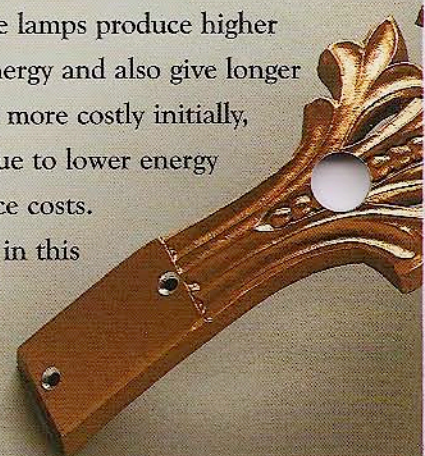

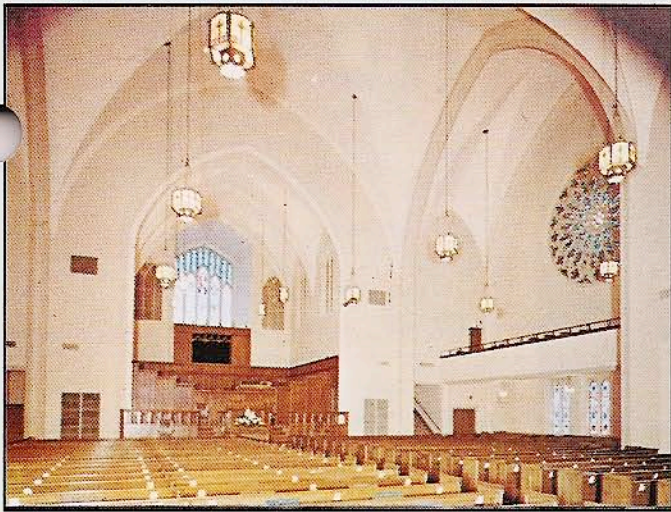

A tradition of quality

Each Traditional style shown in this catalog, whether it be Romanesque, Gothic, or Spanish, features

intricate period details. The beauty of each fixture is hand-made by experienced craftsmen and craftswomen

who form, bend, paint and assemble each fixture in our facility.

The fixture details you see in this catalog are due to individual aluminum castings made in our own foundry. The castings give a depth of detail and appearance superior to the simple sheet metal construction of fixtures offered by others.

Each casting begins with a hand-carved wood pattern. The pattern is used to make a mold in a fine sand. Molten aluminum is poured through the channels in the sand and allowed to cool, forming the metal casting. Each casting is hand-finished to ensure a clean, smooth appearance. The castings are then attached to corner posts or rolled to fit an acrylic cylinder. This process is not the fastest or most inexpensive way to make lighting fixtures.

However, we think you'll agree with the thousands of satisfied Manning customers that it results in a detailed piece of artwork and a superior Traditional appearance.

Table of Contents

French Gothic Page 1 LPI-345 • LBI-334 • CPI-340 CCI-324	Transitional Page 14 LPI-347 • LBE-304 • LBE-652 LBE-327 • LBI-335 • CPI-341 CCI-325
Contemporary Gothic Page 2 LPI-346 • LBI-697 • LBE-301 CPI-302 • CCI-301	Spanish Page 15 LPI-350 • LPI-351 • LBE-329 CPI-342 • CCI-328 • CCI-327
English Gothic Page 3 LPI-577 • LBI-527 • LBE-573 CPI-549 • CCI-603	Georgian Page 16 LPI-552 • LBE-821 • LBI-698 CPI-961 • CCI-719
English Gothic Page 4 LPI-303 • LPI-317 • LBE-814 LBE-820	Colonial Page 17 LPI-313 • LPI-320 • LBE-631 LBE-634 • LBI-319 • CCI-518
Tudor Gothic Page 5 LPI-534 • LBI-508 • LBE-548 CPI-521 • CCI-713	Colonial Page 18 LPI-312 • LBI-337 • CPI-343 CPI-344 • CCI-329
Tudor Gothic Page 6 LPI-660 • LBE-521 • LBE-819 LBI-641 • CPI-839 • CCI-594	Eternalite Page 19 LPI-603 • LPI-577 • LPI-311 LPI-660 • BR-5 • BR-6 • BR-7 CBI-109 • CBI-110 • CBI-125 CBI-126
Gothic Page 7 LPI-305 • LPE-301 • LBE-305 LBI-305 • CPI-305 • CCI-305	Downlights Page 20 S-8040 • S-8052 • S-8056 S-8064 • S-9040 • S-9052 S-9056 • S-9064 • S-8037 S-9037 • R-7040 • R-7052 R-7056 • R-7064 • R-7140 R-7152 • R-7156 • R-7164
Contemporary Gothic Page 8 LPI-353 • LBE-335 • LBI-339 CPI-347 • CCI-331	Spatialite Page 21 GC-146 – GC-446 GC-164 – GC-464 GCQ-164 – GCQ-464
Gothic Page 9 LPI-304 • LPI-542 • LBE-653 LBE-524 • LBE-560 • CCI-503	Spatialite & Spotlight Page 22 SC-446 • SC-464 GCP-146 • GCP-246 GCP-164 • GCP-264 GCV-164 • GCV-264
New England Gothic Page 10 LPI-352 • LBE-334 • LBI-338 LBI-504 • CPI-346 • CCI-330	Specifications, Finishes Page 23
Romanesque Page 11 LPI-603 • LPI-602 • LBI-540 LBE-590 • CPI-561 • CCI-521	Hangers Page 24
Romanesque Page 12 LPI-695 • LBE-626 • CPI-307	
Romanesque Page 13 LPI-308 • LBE-523 • LBI-318 CPI-637 • CCI-716 • CCI-570	

Manning Warranty

Manning Lighting warrants its products against defects in material and workmanship. Manning will, without charge, either repair or replace, or have repaired any properly installed fixture that fails under normal operating conditions within three years of date of shipment. Should defect occur, Manning Lighting reserves the right to decide between replacement and repair, and our inspectors will determine the extent of repair should fixtures be returned to us. This warranty covers only equipment manufactured by Manning Lighting and does not

include transportation, labor or installation charges, nor does it apply to any components not manufactured by Manning Lighting.

This warranty does not cover any defects or damage caused by shipping, improper installation or abuse to the product under normal use. It does not cover any malfunction due to improper maintenance of the fixture.

This warranty is not effective unless written authorization is received from Manning Lighting, concerning the replacement or repair of defective fixtures.

FRENCH GOTHIC

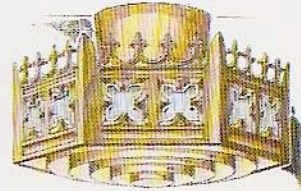
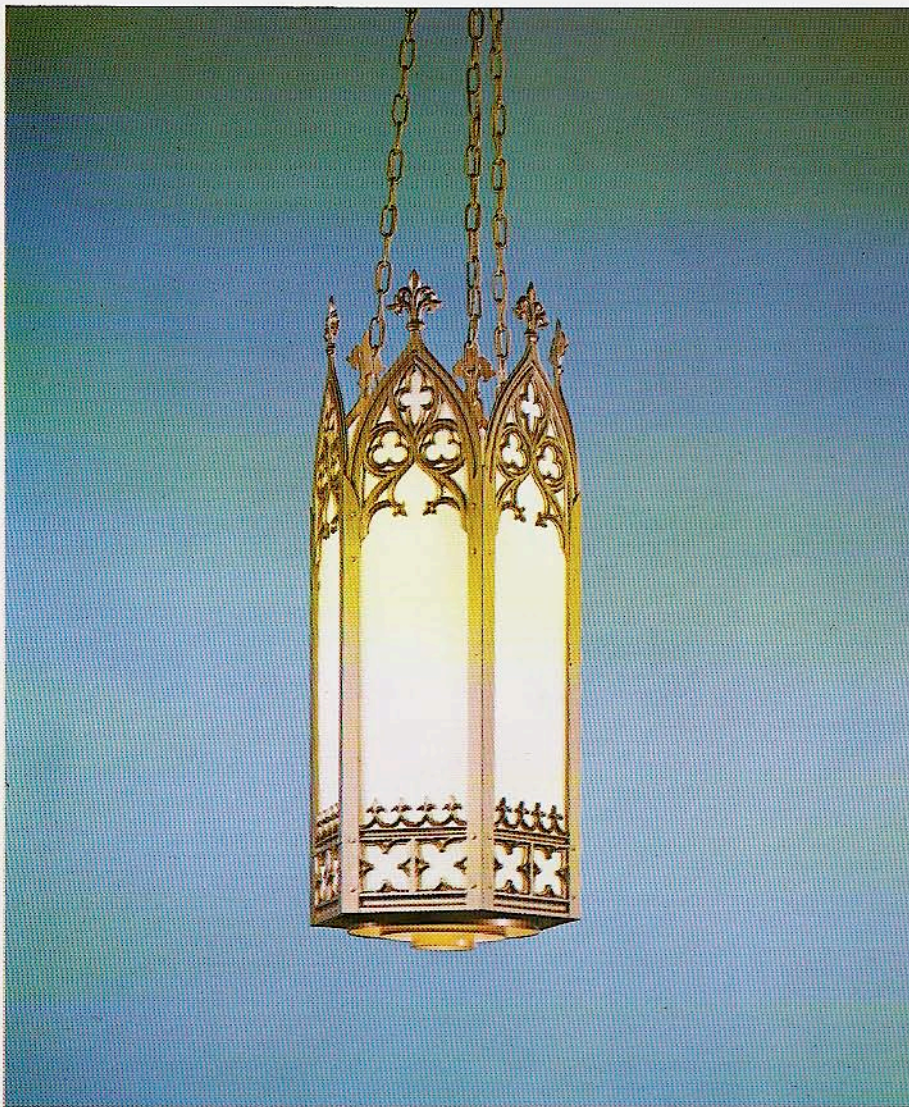

NO. DIA. HT. LTS.
 CCI-324-13R 13 1/4 8 1/4 3-60 W
 -16R 16 1/2 10 3-60 W



NO.	DIA. 'D'	HT. 'H'	LTS.	REFLECTOR LAMP DOWN
LPI-345-11	11 3/4"	25"	4	1-R40 (150-300 W.)
-13	13 1/4"	31"	7	1-R40 (300-500 W.)
-16	16 1/2"	37 1/2"	7	1-R52 (500-750 W.)

WIRED FOR ONE OR TWO CIRCUITS

ENERGY SAVING LAMPING

METAL HALIDE
 DOWN LIGHT

LPI-345-16ES 16 1/2" 37 1/2" 4 3-67A2ITS 1-MV-400/C/U

NO.	DIA. TO LOOP	HT.	LTS.
CPI-340-13	13 1/4"	24"	3-60 W
-16	16 1/2"	30"	3-60 W

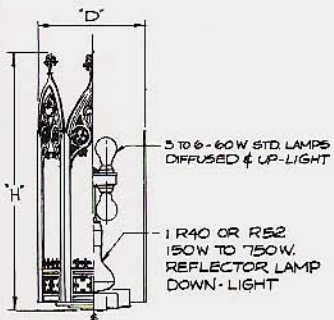

LAMP DIAGRAM - LPI-345-13



CAST
 ALUMINUM

SEE CATALOG
 "TL2" PAGE 2
 FOR LARGER
 MATCHING
 EQUIPMENT

OPTIONAL FINISHES
 AND
 DIFFUSER PANELS
 PAGE 23

NO.	WD.	HT.	EXT.	LTS.
LBI-334	6"	24"	6"	2-60 W

OPEN TOP AND BOTTOM

MANNING
 TRADITIONAL

CONTEMPORARY



NO. DIA. HT. LTS.
 CCI-301-13R 12 3/4" 10" 3-60W
 15R 14 5/8" 10" 3-60W
 17R 16 3/4" 10" 3-60W
 WHITE ACRYLIC PLASTIC BOWL



NO. DIA. HT. LTS.
 CPI-302-12 12 3/4" 14" 3-60W
 -14 14 3/4" 16" 3-60W
 -16 16 3/4" 18" 3-60W
 -18 18 3/4" 20" 6-60W
 ALL METAL UNIT
 WHITE PLASTIC BEHIND GRILLE

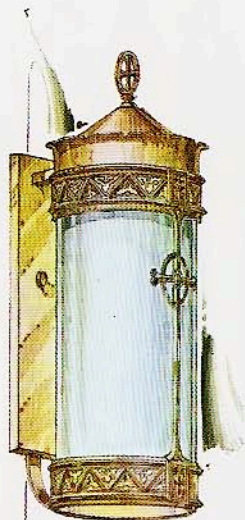

NO. DIA. HT. LTS.
 LBE-301-9 9 1/2" 27" 1-100W
 8" x 20" WHITE ACRYLIC CYLINDER
 OPEN BOTTOM

SEE CATALOG
 "TL2" PAGE 1
 FOR LARGER
 MATCHING
 EQUIPMENT

MANNING
 TRADITIONAL

NO.	DIA. "D"	HT. "H"	CYL. SIZE	LTS.	REFLECTOR LAMP
LPI-346-8	9 3/8"	21 1/2"	8" x 20"	4	1-R40 (150-300W) DOWN
10	11 3/8"	26"	10" x 24"	4	1-R40 (300-300W) DOWN
12	13 3/8"	32"	12" x 30"	7	1-R52 (500-750W) DOWN

WIRED FOR ONE OR TWO CIRCUITS
 WHITE ACRYLIC PLASTIC CYLINDERS

OPTIONAL FINISHES PAGE 23



NO. LETTERS BACKGROUND
 LBI-697-6-RW RED WHITE
 -GW GREEN WHITE

RECESSED BOX 8 1/4" x 13 1/4" x 3 1/4" DEEP
 OUTER FRAME 14 1/2" x 9 3/8"
 2-25WATT LAMPS, 6" LETTERS

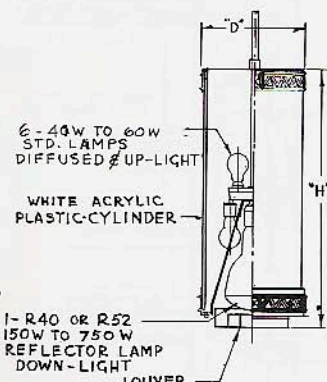

LAMP DIAGRAM-LPI-346-12

✦ ENGLISH GOTHIC ✦

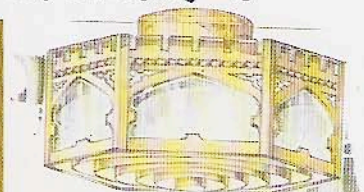
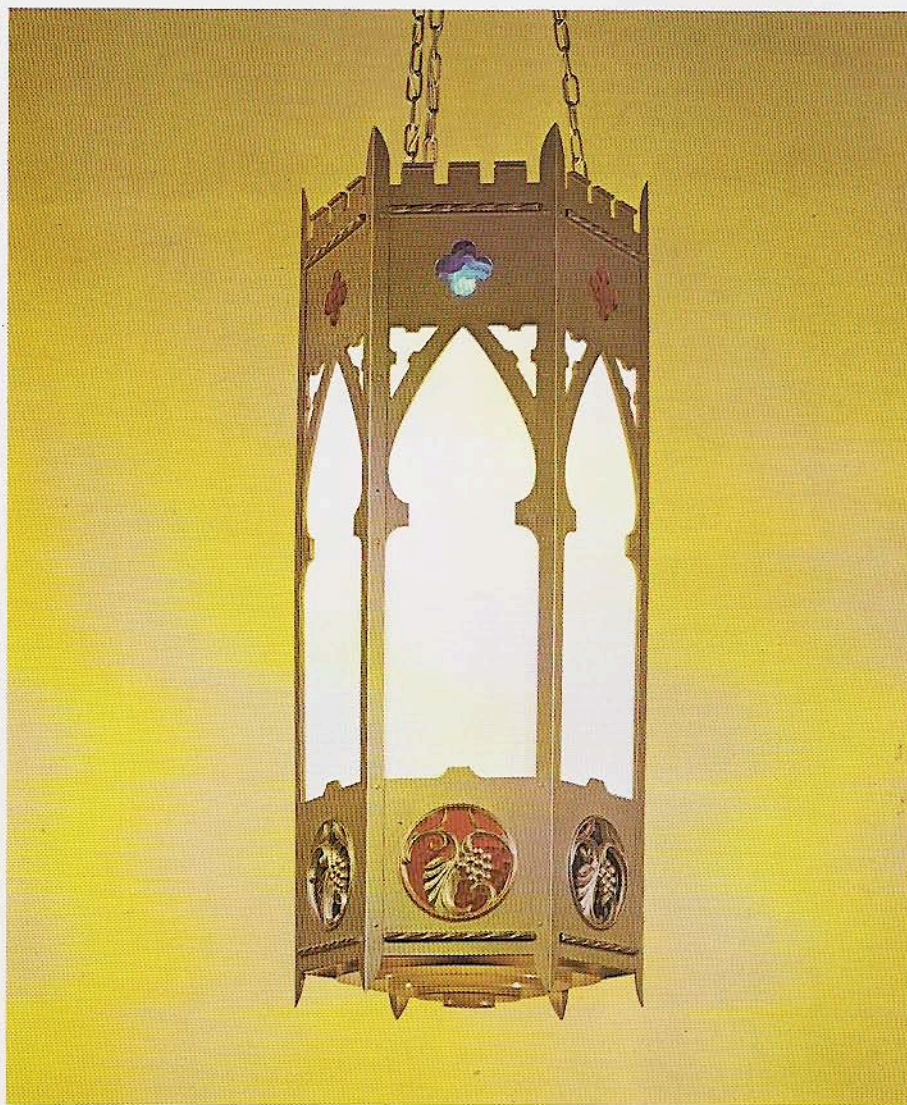

NO.	DIA.	HT.	LTS.
CCI-603-14-LR	13 3/4"	10 1/4"	3-60W
16-LR	16 1/2"	10 5/8"	3-60W
18-LR	18 1/4"	11 1/2"	3-60W

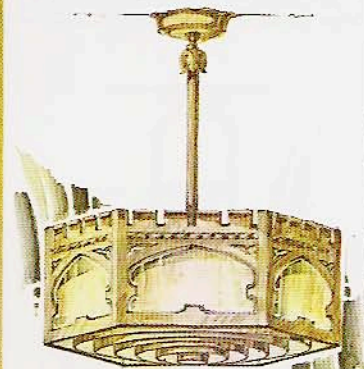

NO.	DIA.	HT.	LTS.
CDI-549-14-L	14 3/4"	15 3/4"	3-60W
-16-L	16 1/2"	19 3/4"	3-60W
-18-L	18 1/4"	21 3/4"	6-60W

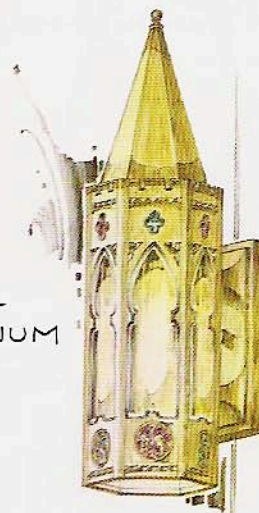

NO.	DIA. D	HT. H	LTS.	REFLECTOR LAMPS		CAST ALUMINUM
				-DOWN-	-UP-	
LPI-577-8A	9 3/8"	20"	1	NONE		
-11A	11 1/2"	23"	4	1-R40(150-300W)		
-13A	13 1/2"	26 1/2"	7	1-R40(300-500W)	3-R40(150-300W)	
-16A	16 1/2"	39 3/4"	7	1-R52(500-750W)	3-R40(150-300W)	
-18A	18"	49 3/4"	10	1-R52(500-750W)	3-R40(150-300W)	

WIRED FOR ONE, TWO OR THREE CIRCUITS

ENERGY SAVING LAMPING			METAL HALIDE DOWNLIGHT	
LPI-577-16ES	16 1/2"	39 3/4"	7	6-67A21TS
				1-MV-400/C/U

OPTIONAL FINISHES AND DIFFUSER PANELS PAGE 23

SEE CATALOG "TL2" PAGE 3 FOR LARGER MATCHING EQUIPMENT

NO.	DIA.	HT.	EXT.	LTS.
LBE-573-B	8 1/4"	29"	10 1/2"	1-100W
-11	11 1/2"	29 1/2"	13"	1-100W

OPEN BOTTOM

NO.	WD.	HT.	EXT.	LTS.
LBE-573-A	8 1/4"	18"	10 1/4"	1-100W

OPEN BOTTOM

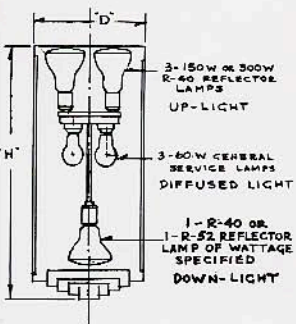

LAMP DIAGRAM LPI-577-15



NO.	WD.	HT.	EXT.	LTS.
LBI-527	8 1/4"	23"	4 1/4"	2-100W

OPEN TOP & BOTTOM



MANNING
TRADITIONAL

✠ ENGLISH GOTHIC ✠

REMOVABLE GASKETED HEAT RESISTANT LENS AT TOP

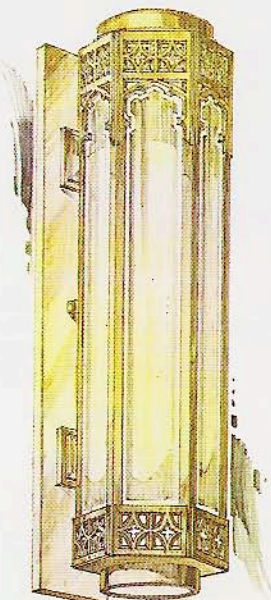

OPEN BOTTOM

NO.	DIA.	HT.	EXT.	LTS.
LBE-814-24	9 1/2"	24"	11"	3
-32	9 1/2"	32"	11"	3

1-PAR.38 FLOODLIGHT UP & DOWN

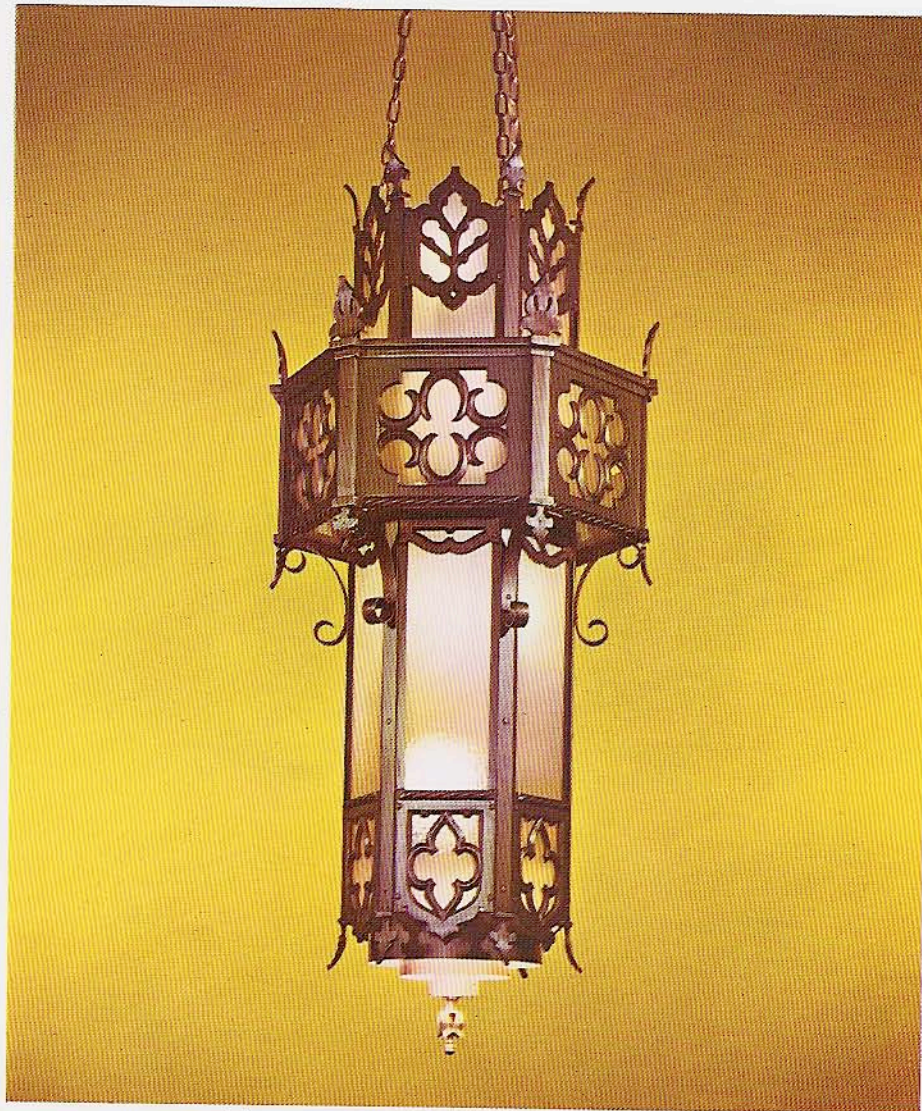
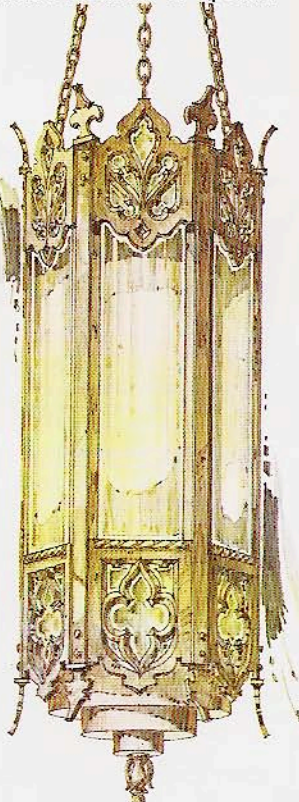

NO.	DIA.'D'	HT.'H'	LTS.	REFLECTOR - DOWN -	LAMPS - UP -
LPI-303-24	24"	53"	10	1-R52(500-750W)	3-R40(150-300W)
-30	30"	70"	13	1-R52(500-750W)	3-R40(150-300W)

WIRED FOR ONE, TWO OR THREE CIRCUITS

OPTIONAL FINISHES AND DIFFUSER PANELS PAGE 23

SEE CATALOG "TL2" PAGE 4 FOR LARGER MATCHING EQUIPMENT

MANNING TRADITIONAL

CAST ALUMINUM



3-150W OR 300W R-40 REFLEC.LAMPS UP-LIGHT

3-60W STR.LAMPS DIFFUSED LIGHT

3-60W STR.LAMPS DIFFUSED LIGHT

1-500W TO 750W R-52 REFLEC.LAMP DOWN-LIGHT

LOUVER

LAMP DIAGRAM LPI-303-24

NO.	DIA.	HT.	LTS.	REFL. LAMPS
LPI-317-15	15"	42"	7	1-R52(500-750W)DOWN 3-R40(150-300W)UP
-17	17"	55"	10	1-R52(500-750W)DOWN 3-R40(150-300W)UP

ENERGY SAVING LAMPING

NO.	DIA.	HT.	EXT.	LTS.
LBE-820-20	9 1/2"	20"	5"	1-100W
	32	9 1/2"	32"	5" 1-150W

1-MV-400/C/U DOWN
METAL HALIDE DOWNLIGHT HINGED BOTTOM

+ TUDOR GOTHIC +

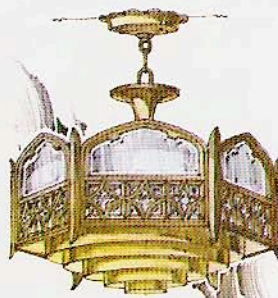
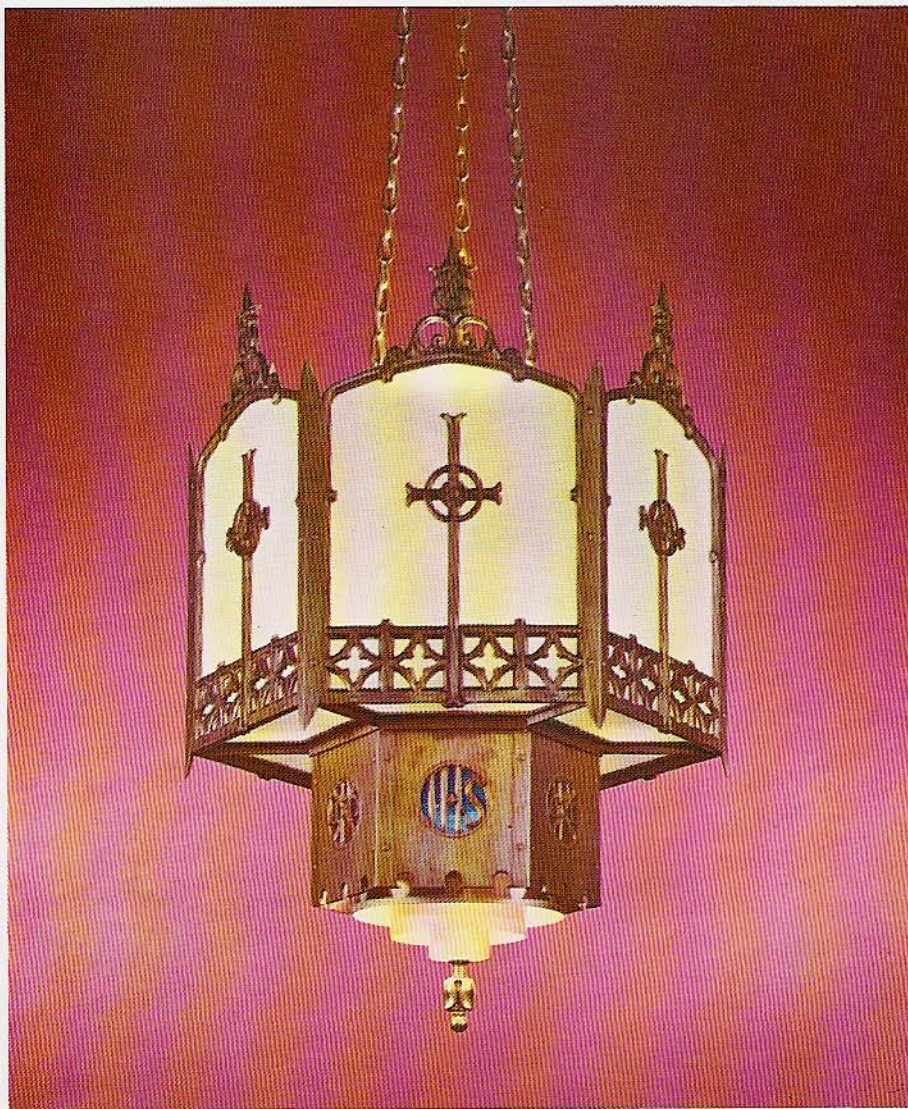

NO.	DIA.	HT.	LTS.
CPI-321-14L	14 3/8"	16"	3-60W
16L	16 1/2"	18"	6-60W
18L	18 1/2"	20"	6-60W

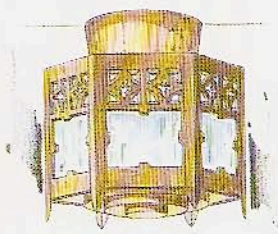

NO.	DIA.	HT.	LTS.
CCI-713-11R	12"	12"	3-60W.
-13R	14 1/2"	14"	3-60W.

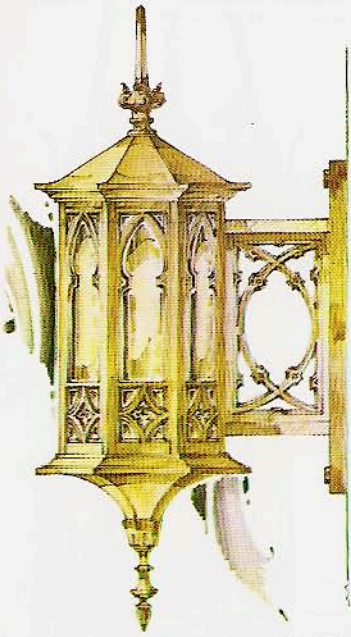

NO.	DIA. D	HT. H	LTS.	REFLECTOR	LAMPS
LPI-534-18	18"	27"	8	1-R40(150-300W)DOWN	1-R40(150-300W)UP
-24	24"	32"	10	1-R40(150-300W)DOWN	3-R40(150-300W)UP
-28	28"	38"	15	3-R40(150-300W)DOWN	6-R40(150-300W)UP
-36	36"	45"	19	1-R52(500-750W)DOWN	6-R40(150-300W)UP
-48	48"	57"	19	1-R52(500-750W)DOWN	6-R40(300-500W)UP

WIRED FOR ONE, TWO OR THREE CIRCUITS

ENERGY SAVING LAMPING

METAL HALIDE DOWNLIGHT

LPI-534-36ES 36' 45' 13 12-67A21TS 1-MV-400/C/U

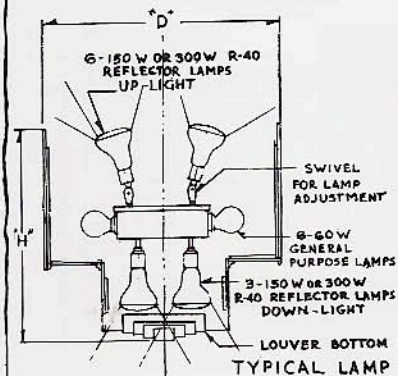

TYPICAL LAMP DIAGRAM
LPI-534-28 (SHOWN)

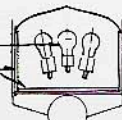
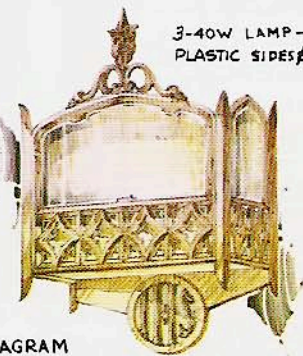

LAMP DIAGRAM
LBI-508

SEE CATALOG "TL2" PAGE 7. FOR LARGER MATCHING EQUIPMENT

NO.	WIDTH	HT.	EXT.	LTS.
LBI-508	14"	21"	6 1/2"	3-40W

SEE LAMP DIAGRAM ABOVE

NO.	DIA.	HT.	EXT.	LTS.
LBE-548-15	14 1/2"	38"	19"	1-200W
-19	19"	52"	25 1/2"	1-300W

OCTAGON

OPTIONAL FINISHES AND DIFFUSER PANELS PAGE 23.

MANNING
TRADITIONAL

+ TUDOR GOTHIC +

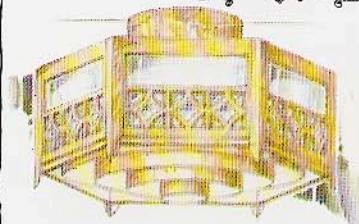

NO.	DIA.	HT.	LTS.
CCI-594-14-LR	14 3/4"	9 1/2"	3-60W
16-LR	16 2/4"	10"	3-60W
18-LR	18 1/4"	10"	3-60W

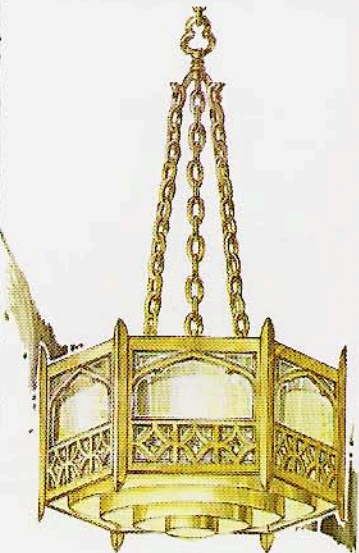

NO.	DIA.	HT. TO LOOP	LTS.
CPI-839-16	16 1/8"	30"	3-60W
-18	18 1/4"	34"	6-60W
-20	20 1/8"	38"	6-60W

-A WITH DOWN LIGHT



MANNING
TRADITIONAL

NO.	DIA.	HT.	EXT.
LBE-521-10	10"	36"	11 1/2"
-12	12"	48"	14 1/2"
-10			100W LAMP
-12			150W LAMP

SEE CATALOG
"TL2" PAGE 6
FOR LARGER
MATCHING
EQUIPMENT

NO.	DIA. D	HT. H	LTS.	REFLECTOR LAMPS
LPI-660-8	8 1/4"	19"	1	NONE
-11	11 1/2"	23"	4	1-R40(150-300W) DOWN
-13	13 1/2"	27 1/4"	7	1-R40(300-500W) DOWN 3-R30(75W) UP
-16	16 1/2"	39 3/4"	7	1-R52(500-750W) DOWN 3-R40(150-300W) UP
-18	18 1/2"	50"	7	1-R52(300-750W) DOWN 3-R40(150-300W) UP

WIRED FOR ONE, TWO OR THREE CIRCUITS
ENERGY SAVING LAMPING METAL HALIDE
DOWN

LPI-660-16ES 16 1/2" 39 3/4" 7 6-67AZITS 1-MV-400/C/U



NO.	DIA.	HT.	EXT.	LT.
LBE-819	8 1/4"	20"	10"	1-100W

OPEN BOTTOM

OPTIONAL FINISHES
AND
DIFFUSER PANELS
PAGE 23

NO.	DIA.	HT.	EXT.
LBI-641	8 1/4"	22"	5"

2-60W LAMPS

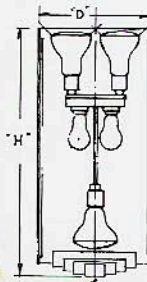

LAMP DIAGRAM LPI-660-13

+ GOTHIA +

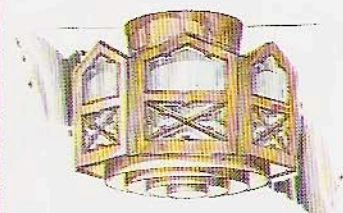
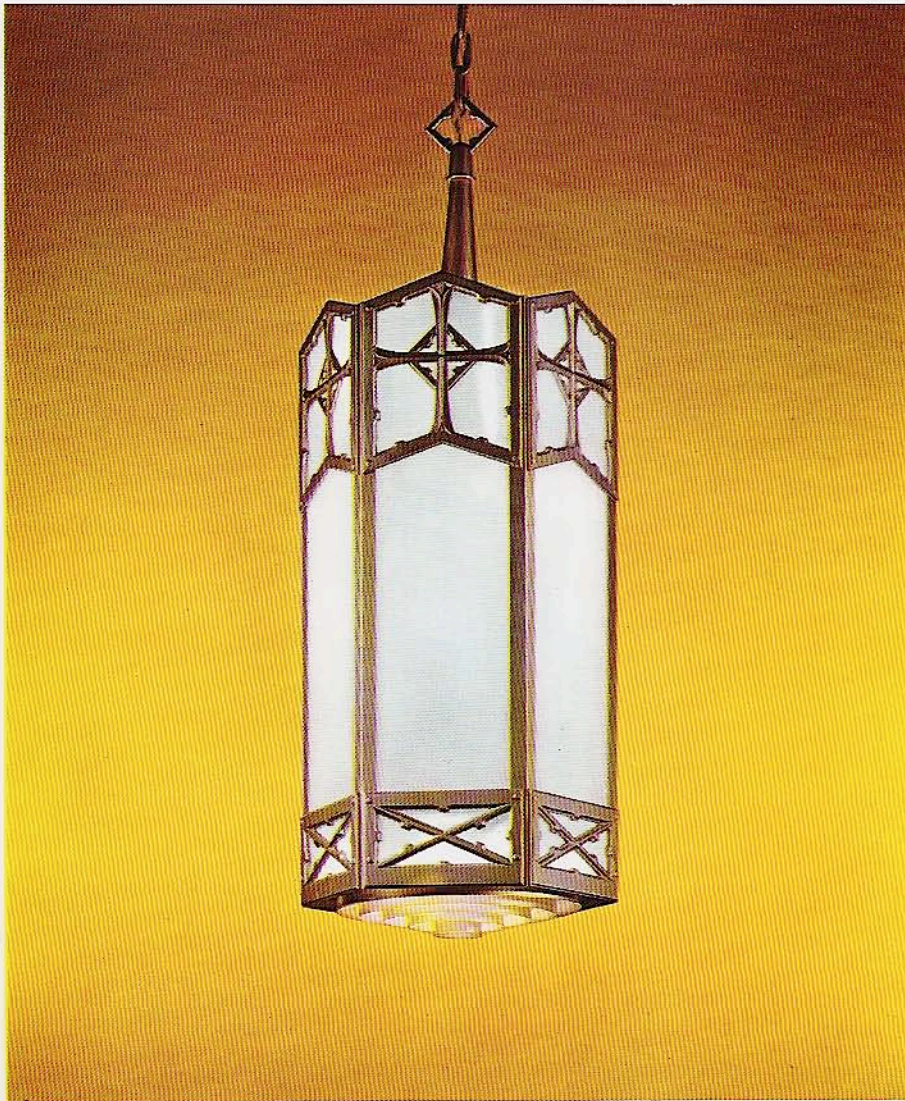

NO.	DIA.	HT.	LTS.
CCI-305-11R	11½"	10"	3-60W
-13R	13½"	10"	3-60W
-16R	16½"	12½"	3-60W

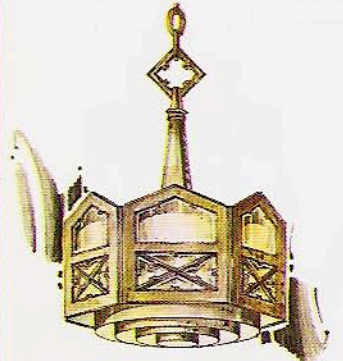

NO.	DIA.	HT.	LTS.
CPI-305-13	13½"	18"	3-60W
-16	16½"	21"	6-60W

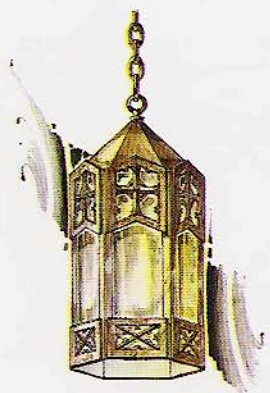

NO.	DIA.	HT.	LTS.
LPE-301-8	8¼"	18"	1-100W
-11	11½"	22"	1-150W

OPEN BOTTOM

SEE CATALOG 'TL2' PAGE 5 FOR LARGER MATCHING EQUIPMENT

NO.	DIA.	HT.	EXT.	LTS.
LBI-305	8¼"	16"	5"	1-60W

OPEN BOTTOM

MANNING
TRADITIONAL

NO.	DIA. D"	HT. H"	LTS.	REFLECTOR	LAMPS
LPI-305-8	8¼"	26"	1	-DOWN- NONE	-UP- NONE
-11	11½"	29"	4	1-R40(150-300W)	NONE
-13	13½"	39"	4	1-R40(300-500W)	NONE
-16	16½"	45½"	7	1-R52(300-750W)	3-R40(150-300W)
-18	18½"	56½"	7	1-R52(300-750W)	3-R40(150-300W)

WIRED FOR ONE, TWO OR THREE CIRCUITS
 ENERGY SAVING LAMPING METAL HALIDE DOWNLIGHT
 LPI-305-16ES 16½" 45½" 7 6-67A2ITS 1-MV-400/C/U

CAST ALUMINUM

OPTIONAL FINISHES AND DIFFUSER PANELS PAGE 23



NO.	DIA.	HT.	EXT.	LTS.
LBE-305-8	8¼"	18"	10¾"	1-100W
-11	11½"	22"	13"	1-150W

OPEN BOTTOM

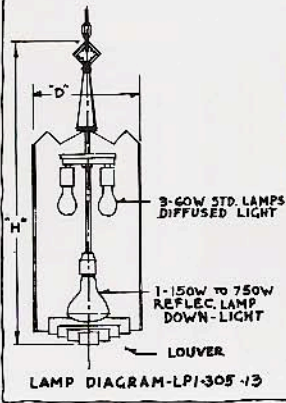

+ G C O N T E M P O R A R Y C +

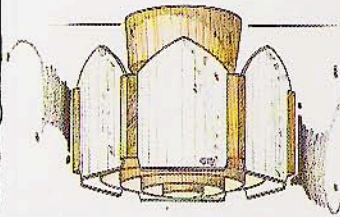

NO. DIA. HT. LTS.
 CCI-331-11R 11½" 10" 3-60W.
 -13R 13½" 10" 3-60W.
 -16R 16½" 12½" 3-60W.

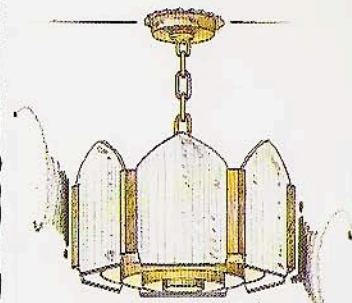

O.A.
 NO. DIA. HT. LTS.
 CPI-347-13 13½" 15½" 3-60W.
 -16 16½" 19½" 3-60W.

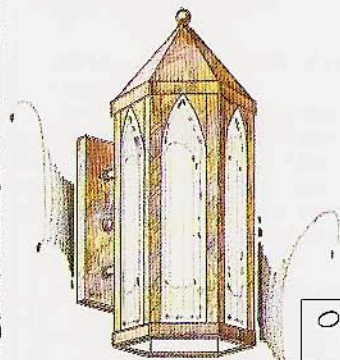

NO.	DIA."D"	HT."H"	LTS.	REFLECTOR LAMP
LPI-353-8	8½"	22"	1	- NONE -
-11	11¾"	26¾"	4	1-R40 (150-300W)-DN.
-13	13¼"	32"	7	1-R40 (300-500W)-DN.
-16	16⅝"	38"	7	1-R40 (300-500W)-DN

WIRED FOR ONE OR TWO CIRCUITS
 ENERGY SAVING LAMPING
 LPI-353-16ES 16⅝" 38" 7 1-250 W.METAL HALIDE BALLAST MOUNTED REMOTE

OPTIONAL FINISHES
 AND
 DIFFUSER PANELS
 PAGE 23

NO. DIA. HT. EXT. LTS.
 LBE-335-8 8½" 20" 10¼" 1-100W.

NO. DIA. HT. EXT. LTS.
 LBI-339 8½" 16" 4¼" 2-60W.

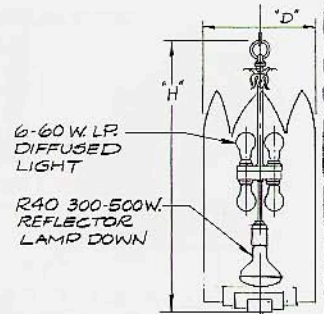
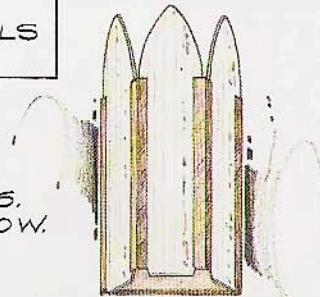

LAMPING DIAGRAM
 LPI-353-13

+ GOTHIA +

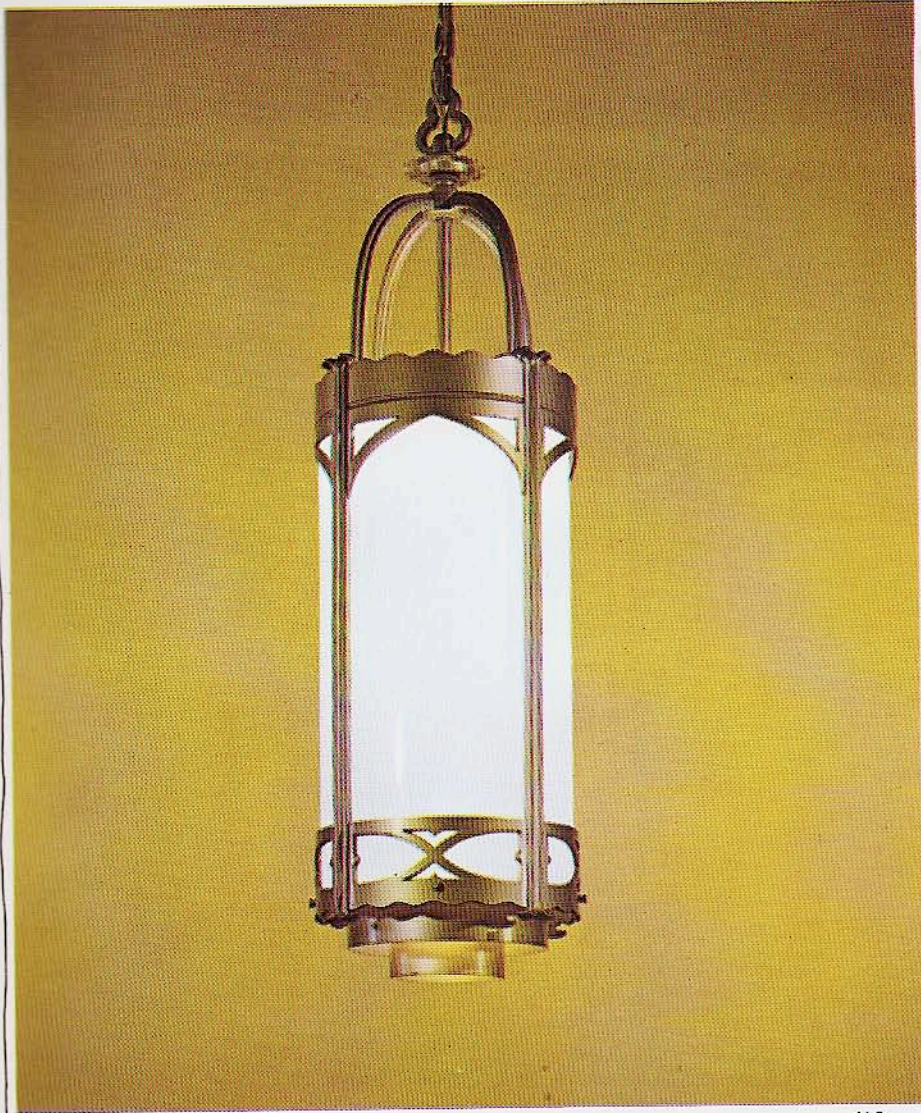

NO. DIA. HT. LTS.
 CCI-503-12R 12 1/4" 10 1/4" 3-60W
 -14R 13 3/4" 10 1/4" 3-60W
 -16R 16 1/4" 10 1/4" 3-60W
 WHITE ACRYLIC PLASTIC BOWL

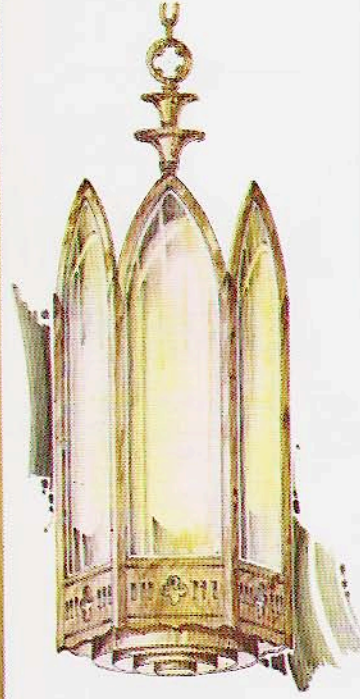

NO.	DIA. D"	HT. H"	CYL. SIZE	LTS.	REFLECTOR	LAMPS
LPI-304-9	9 1/2"	25 3/4"	8" x 14"	1	NONE	NONE
-11	11 1/2"	34 3/4"	10" x 18"	4	1-R40 (150-300W)	DOWN
-13	13 1/2"	42 1/2"	12" x 22"	7	1-R40 (300-500W)	DOWN
					3-R40 (150-300W)	UP
-17	17 1/2"	55 1/2"	16" x 30"	7	1-R52 (500-750W)	DOWN
					3-R40 (150-300W)	UP

NO.	DIA. D"	HT. H"	LTS.	REFL.	LAMPS
LPI-542-8	8 1/4"	24 3/4"	1	NONE	NONE
-11	11 1/2"	30"	4	1-R40 (150-300W)	
-13	13 1/2"	33 1/2"	4	1-R40 (300-500W)	
-16	16 1/2"	46 1/2"	7	1-R52 (500-750W)	

WIRED FOR ONE OR TWO CIRCUITS

ENERGY SAVING LAMPING METAL HALIDE LAMP
 LPI-304-17ES 17 1/2" 55 1/2" 16" x 30" 4 3-67A21TS 1-MV-400/C/U
 WIRED FOR ONE, TWO OR THREE CIRCUITS
 OPTIONAL FINISHES & DIFFUSER PANELS
 PAGE 23



SEE CATALOG "TL2" PAGE 9 FOR LARGER MATCHING EQUIPMENT

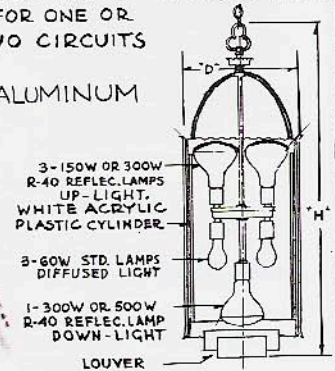
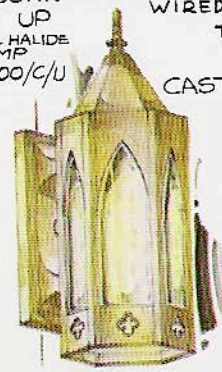

NO. DIA. HT. EXT. LBS.
 LBE-653 10" 16" 3 3/4" 1-40W LAMP

NO. DIA. HT. EXT. LBS.
 LBE-524 5 1/2" 13" 8" 1-60W LAMP OPEN BOTTOM

NO. DIA. HT. EXT. LTS.
 LBE-560-8 8" 21" 10 1/4" 1-100W
 -9 9 3/4" 32" 10 3/4" 1-150W
 -11 11" 39" 11 3/4" 1-200W
 OPEN BOTTOM

LAMP DIAGRAM LPI-304-13

MANNING
 TRADITIONAL

NEW ENGLAND

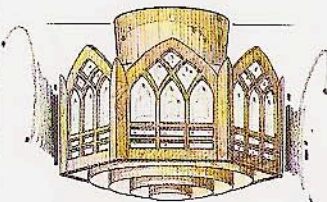

NO. DIA. HT. LTS.
 CCI-330-11R 11½" 9½" 3-60W.
 -13R 13½" 10" 3-60W.
 -16R 16½" 12½" 3-60W.

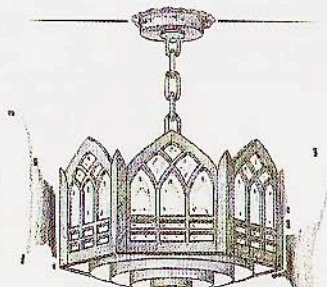

NO. DIA. HT. LTS.
 CPI-346-13 13½" 15½" 3-60W.
 -16 16½" 19¾" 3-60W.

NOTE! COLOR OF FINISH ON PHOTOGRAPHED FIXTURE IS ANTIQUE SILVER.

CAST ALUMINUM

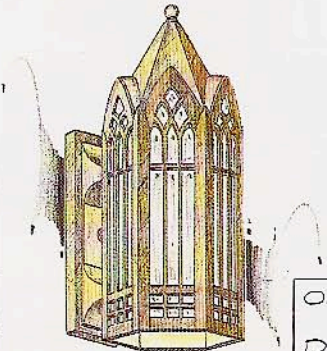

NO.	DIA. "D"	HT. "H"	LTS.	REFLECTOR LAMP
LPI-352-8	8½"	16½"	1	-NONE-
-11	11⅞"	20¾"	4	1-R40 (150-300W.)-DN.
-13	13¼"	25"	7	1-R40 (300-500W.)-DN.
-16	16⅝"	31"	7	1-R42 (500-750W.)-DN.

WIRED FOR ONE OR TWO CIRCUITS
 ENERGY SAVING LAMPING
 LPI-352-16ES 16⅝" 31" 7 1-250 W. METAL HALIDE BALLAST MOUNTED REMOTE

OPTIONAL FINISHES AND DIFFUSER PANELS PAGE 23

NO. DIA. HT. EXT. LT.
 LBE-334-B 8½" 20" 10¼" 1-100W.

NO. DIA. HT. EXT. LTS.
 LBI-33B 8½" 16" 4⅞" 2-60W.



ROMANESQUE EXIT LIGHT
 6" LETTERS
 LBI-504-6-RW RED WHITE
 -GW GREEN WHITE
 RECESSED BOX 8¼" x 13¼" x 3¼" DEEP
 OUTER FRAME 14½" x 12½"
 2-25 WATT LAMPS, 6" LETTERS

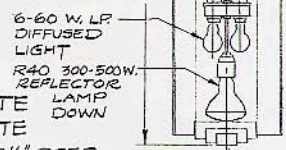

LAMPING DIAGRAM LPI-352-13

MANNING TRADITIONAL

✦ ROMANESQUE ✦

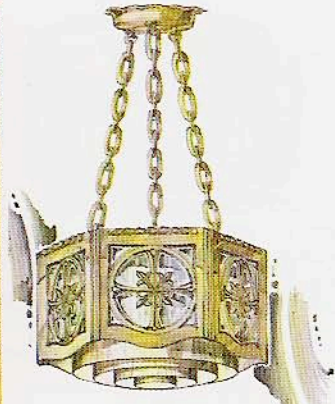
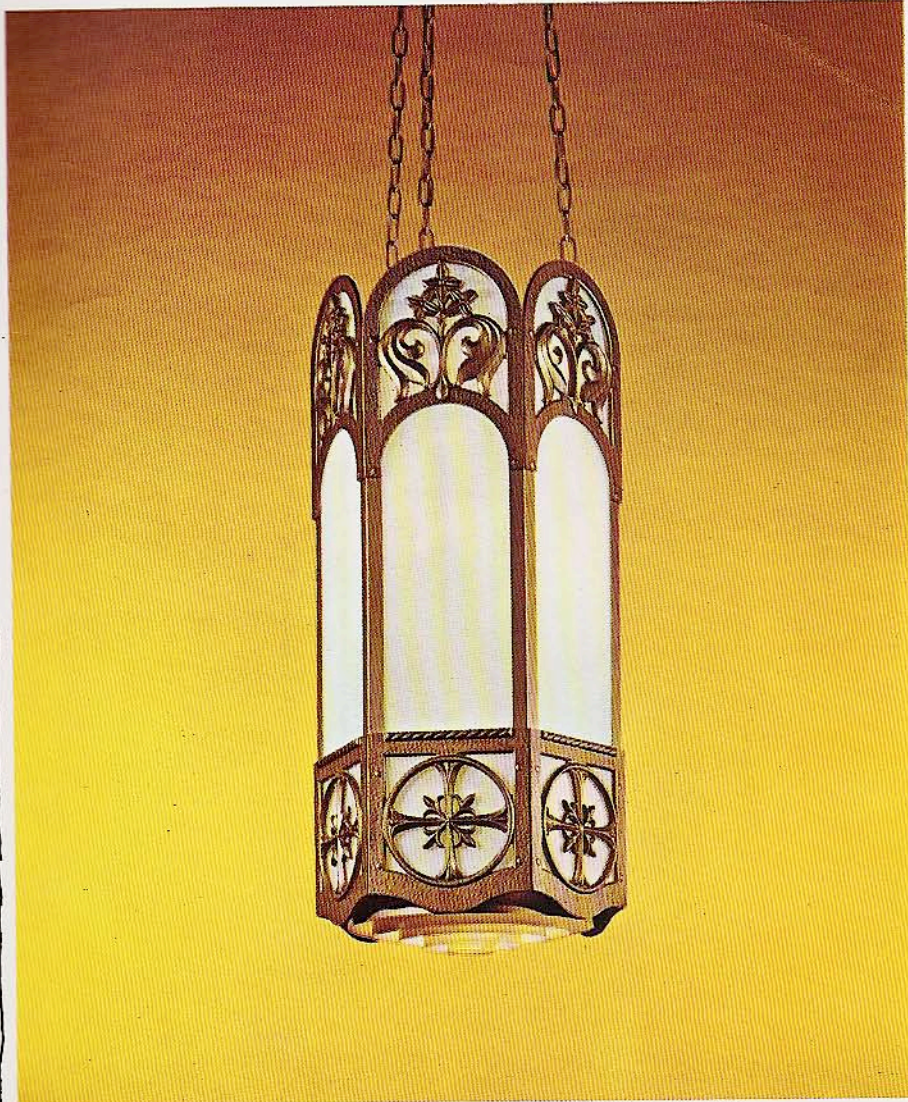

NO.	DIA.	MIN. HT.	HT. O.F.
CPI-561-13	13"	13"	26"
-16	16"	18"	36"
-18	18"	18"	42"

LAMPING: CPI-561-13 3-60W.
CPI-561-16 6-60W.
CPI-561-18 6-60W.



NO.	DIA. D*	HT. H*	LTS.	REFLECTOR LAMPS	
				-DOWN-	-UP-
LPI-603-13	13"	26 $\frac{1}{2}$ "	7	1-R40(300-500W)	3-R20(75W)
-16	16"	34"	7	1-R52(500-750W)	3-R20(150-300W)
-18	18"	36 $\frac{1}{2}$ "	7	1-R52(500-750W)	3 R40(150-300W)

WIRED FOR ONE, TWO OR THREE CIRCUITS

NO.	DIA. D*	HT. H*	LTS.	REFLECTOR LAMP
LPI-602-8	8"	19" 1		NONE
-11	11"	27" 4		1-R40(150-300W) DOWN
-13	13"	33" 4		1-R40(600-500W) DOWN
-16	16"	39" 4		1-R52(500-750W) DOWN

WIRED FOR ONE OR TWO CIRCUITS
SEE LAMP DIAGRAM BELOW

ENERGY SAVING LAMPING ^{METAL HALIDE} ^{DOWNLIGHT}
LPI-603-16ES 16" 34" 7 6-67A2ITS 1-MV-400/c/u

HAMMERED FINISHES & OPTIONAL DIFFUSER PANELS -
PAGE 23

CAST ALUMINUM

NO. DIA. HT. EXT.
LBI-540 8" 17 $\frac{1}{2}$ " 4 $\frac{1}{2}$ "
1 LT. OPEN TOP & BOTTOM
100 WATT CAPACITY

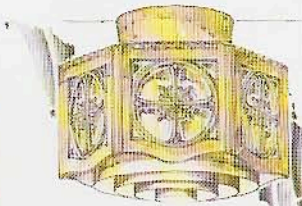
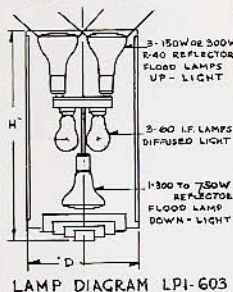

NO.	DIA.	HT.	LTS.
CCI-521-13R	13"	10"	3-60W
-16R	16 $\frac{1}{4}$ "	12"	3-60W
-18R	18 $\frac{1}{4}$ "	13"	3-60W

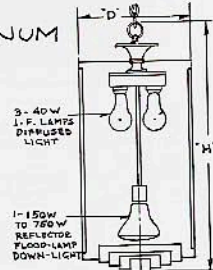

MANNING
TRADITIONAL

SEE CATALOG 'TL2' PAGE 11 FOR LARGER MATCHING EQUIPMENT

ROMANESQUE



NO. DIA. HT. EXT. LTS.
 LBE-626-9 9 1/2" 24" 4 3/4" 2-100W
 -12 12 3/4" 36" 6 1/2" 2-150W
 HINGED BOTTOM

OPTIONAL
 HAMMERED
 FINISHES
 AND
 DIFFUSER
 PANELS
 PAGE 23

CAST
 ALUMINUM



NO.	DIA. D"	HT. H"	LTS.	REFLECTOR LAMPS
				- DOWN - - UP -
LPI-695-24	25 1/2"	41"	11	1-R40(300-500W) 1-R40(150-300W)
-30	30"	48"	17	1-R52(500-750W) 3-R30(75W)
-52	52"	90"	20	1-R52(500-750W) 3-R40(150-300W)

ENERGY SAVING LAMPING METAL HALIDE DOWNLIGHT
 LPI-695-30ES 30" 48" 17 16-67A2ITS 1-MV-400/C/U

WIRED FOR ONE, TWO OR THREE CIRCUITS

NO.	DIA. D"	HT. H"	LTS.	REFLECTOR LAMP
CPI-307-24	25 1/2"	42"	7	1-R40(300-500W) DOWN
CPI-307-30	30"	46"	7	1-R40(300-500W) DOWN

WIRED FOR ONE OR TWO CIRCUITS

SEE CATALOG "TL2" PAGE 11
 FOR LARGER
 MATCHING EQUIPMENT.

MANNING
 TRADITIONAL

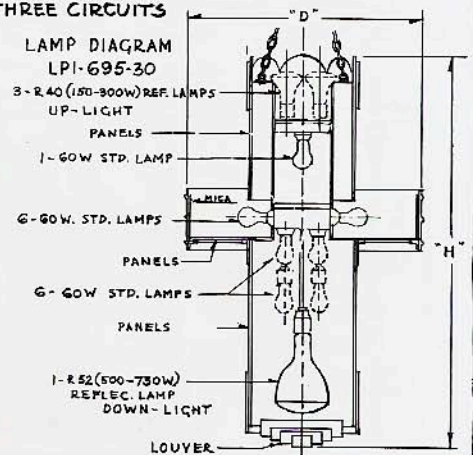
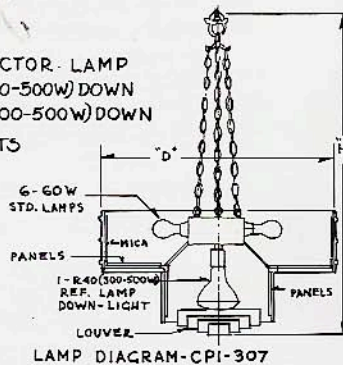

✦ ROMANESQUE ✦

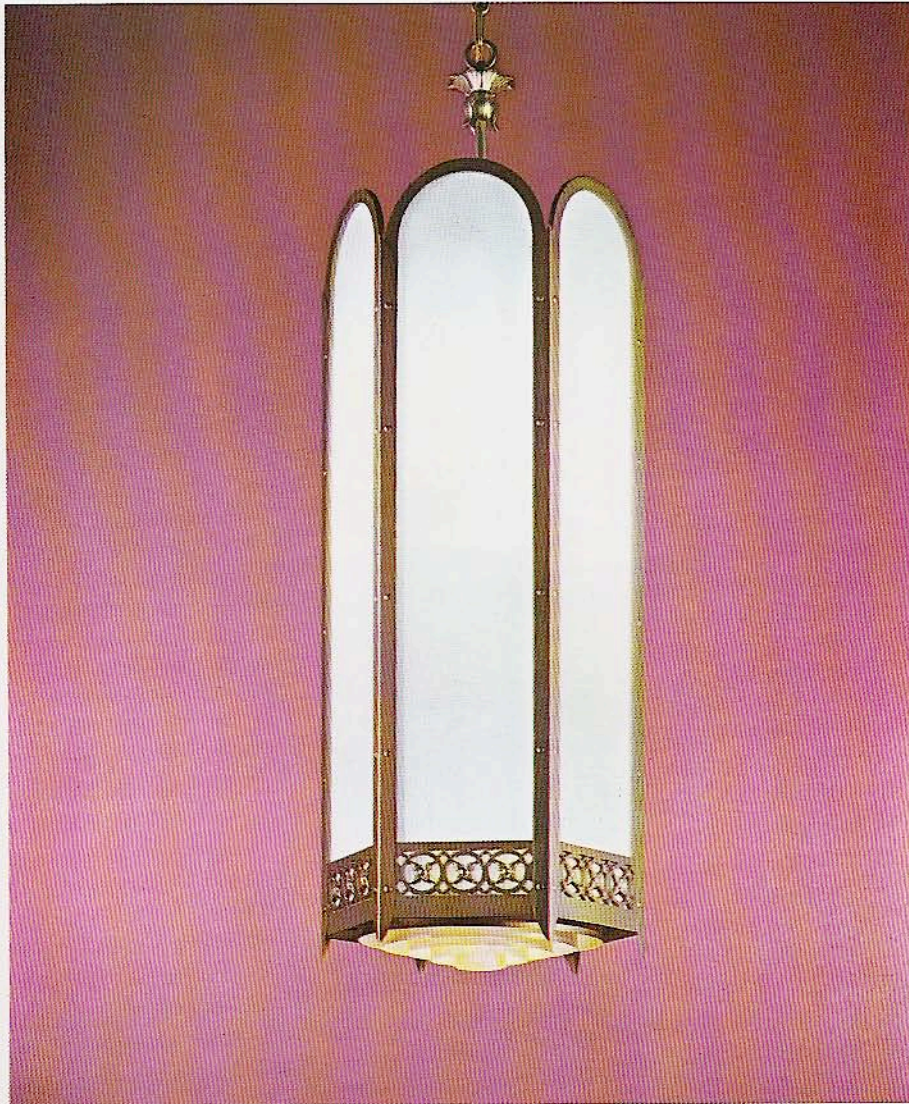

NO.	DIA.	HT.	LTS.
CCI-570-12R	12 1/4"	10 3/4"	3-60W
-14R	13 3/4"	10 3/4"	3-60W
-16R	16 1/4"	10 3/4"	3-60W

WHITE ACRYLIC PLASTIC BOWL

NO.	DIA.	HT.	LTS.
CCI-716-14R	15 1/4"	12 1/2"	3-60W
-16R	17 1/2"	14"	3-60W
-18R	19 1/4"	13 1/2"	3-60W

NO.	DIA.	HT.	LTS.
CPI-637-14-L	14"	17"	3-60W
16-L	16"	19"	3-60W
18-L	18"	21"	6-60W

NO.	DIA. D*	HT. H*	LTS.	REFLECTOR LAMP
LPI-308-9	9 3/4"	25 1/2"	1	DOWN
-11	11 1/2"	29"	4	NONE
-13	13"	32 1/2"	4	1-R40 (150-300 W)
-16	16"	51 1/2"	7	1-R40 (300-500 W)
				1-R52 (500-750 W)

WIRED FOR ONE OR TWO CIRCUITS

ENERGY SAVING LAMPING
LPI-308-16ES 16" 51 1/2"

METAL HALIDE DOWNLIGHT
7 6-67AZITS 1-MV-400/C/U

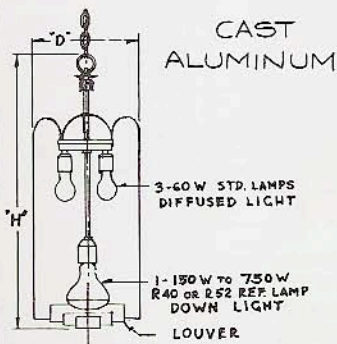

LAMP DIAGRAM LPI-308



SEE CATALOG "TL2" PAGE 12 FOR LARGER MATCHING EQUIPMENT

OPTIONAL FINISHES AND DIFFUSER PANELS
PAGE 23.

NO.	DIA.	HT.	EXT.	LTS.
LBE-523-8	8 1/2"	19 1/2"	9 3/4"	1-100W
-11	11 1/2"	25 1/2"	12 3/4"	1-150W

OPEN BOTTOM

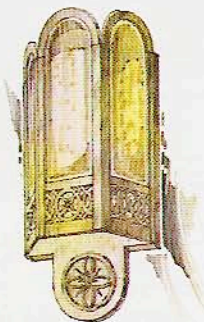

NO.	DIA.	HT.	EXT.
LBI-318	8 1/4"	18"	4 1/2"

1-60W. LAMP

MANNING TRADITIONAL

TRANSITIONAL

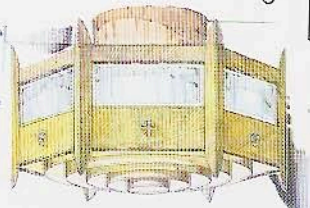

NO. DIA. HT. LTS.
 CCI-325-13R 13 1/4" 10 1/4" 3-60W
 -16R 16 1/2" 10 3/8" 3-60W

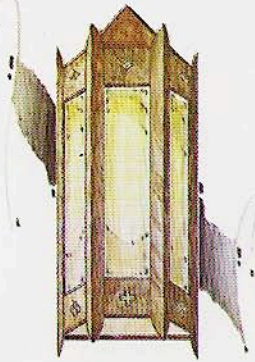

OPEN BOTTOM
 NO. DIA. HT. EXT. LTS.
 LBE-327 8 3/8" 21 1/2" 4 1/8" 1-100W

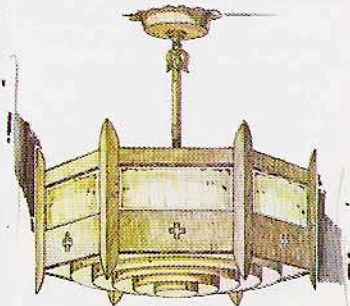

NO. DIA. HT. LTS.
 CPI-341-13 13 1/4" 15 3/8" 3-60W
 -16 16 1/2" 19 3/8" 6-60W

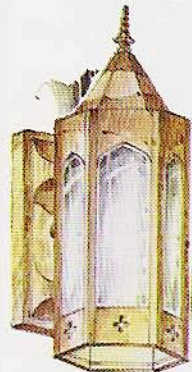
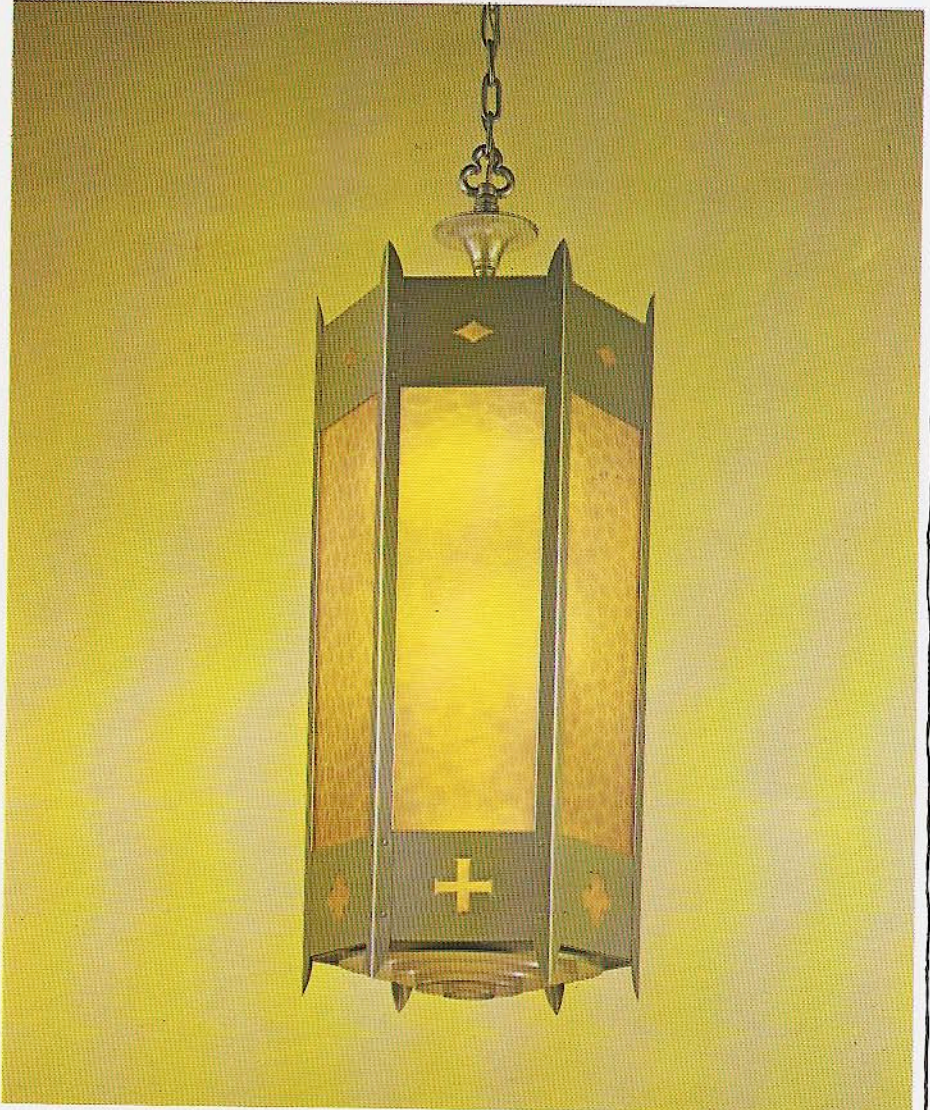

NO. DIA. HT. EXT. LTS.
 LBE-652-8 8 3/4" 21" 10 1/4" 1-100W LAMP
 LBE-652-10 10" 27 1/2" 12" 1-150W LAMP
 OPEN BOTTOM

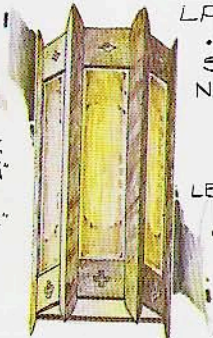

NO.	DIA. "D"	HT. "H"	LTS.	REFLECTOR LAMP DOWN
LPI-347-8	8 1/2"	23 3/8"	1	-NONE-
-11	11 3/8"	28"	4	1-R40 (150-300W)
-13	13 1/4"	32 1/4"	7	1-R40 (300-500W)
-16	16 3/8"	39 5/8"	7	1-R52 (500-750W)



WIRED FOR ONE OR TWO CIRCUITS
 OPTIONAL CROSS IN EVERY OTHER LOWER PANEL - ADD -A TO FIXTURE NUMBER.

ENERGY SAVING LAMPING METAL HALIDE DOWN LIGHT
 LPI-347-16ES 16 3/8" 39 5/8" 4 3-67A21TS 1-MV-400/C/U

• STANDARD FINISHES:
 SATIN GOLD OR
 NATURAL BRONZE

• DIFFUSER PANELS:
 HAMMERED CATHEDRAL
 ACRYLIC OR WHITE
 ACRYLIC

OPEN TOP & BOTTOM
 NO. DIA. HT. EXT. LTS.
 LBI-335 8 3/8" 19" 4 1/8" 2-60W

NO. DIA. HT. EXT. LTS.
 LBE-304 8" 16" 4 1/4" 1-60W
 OPEN BOTTOM



LAMP DIAGRAM

LPI-346-16
 (6) 60W LPS
 DIFFUSED
 LIGHT

R52 (600-750W)
 REFLECTOR
 LAMP-DOWN

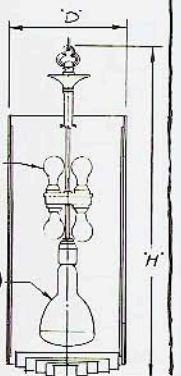

MANNING
 TRADITIONAL

NOTE: NO CROSS
 OPTIONS ON
 LBE-652 & LBE-304

SEE CATALOG "TL2"
 PAGE 8 FOR LARGER
 MATCHING EQUIPMENT

♦ SPANISH ♦



NO. DIA. HT. LTS.
 CCI-327-12R 12¼ 10¾ 3-60W.
 -14R 13¾ 10¾ 3-60W.
 -16R 16¼ 10¾ 3-60W.
 WHITE ACRYLIC PLASTIC BOWL

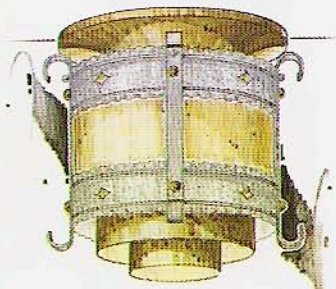

NO. DIA. HT. LTS.
 CCI-328-10 13½ 11½ 3-60W.
 -12 15½ 14¼ 3-60W. &
 I-R40 (150-300W.) DOWN LIGHT
 PENDANT TYPE OF ABOVE

NO. DIA. HT. LTS.
 LPI-351-10 13½ 10¾ 3-60W.
 -12 15½ 13 3-60W. &
 I-R40 (150-300W.) DOWN LIGHT
 WIRED FOR ONE OR TWO CIRCUITS

PLASTIC
 CYLINDER SIZE
 CCI-328-10 10" x 6"
 -12 12" x 8"
 LPI-351-10 10" x 6"
 -12 12" x 8"

NO.	DIA'D'	HT.'H'	CYL. SIZE	INTER. LTS.	REFLECTOR LAMPS
LPI-350-8	12¾	21½	8" x 16"	1-150 W.	-NONE-
-10	16¾	25½	10" x 18"	3-(60-100W.)	I-R40(300-500W.) DOWN
-12	18½	31½	12" x 22"	6-(60-100W.)	I-R52(500-750 W.) DOWN
-14	21¼	37½	14" x 26"	6-(60-100W.)	I-R52(500-750W.) DOWN

WHITE, IVORY OR AMBER PLASTIC CYLINDER
 WIRED FOR ONE OR TWO CIRCUITS

ANTIQUE HAMMERED
 STEEL AND GOLD
 FINISH

NO. DIA. HT. EXT. LTS.
 LBE-329-6 9¾ 17¾ 10¾ 1-100W.
 -8 11¾ 22¾ 12¾ 1-150W.
 OPEN BOTTOM

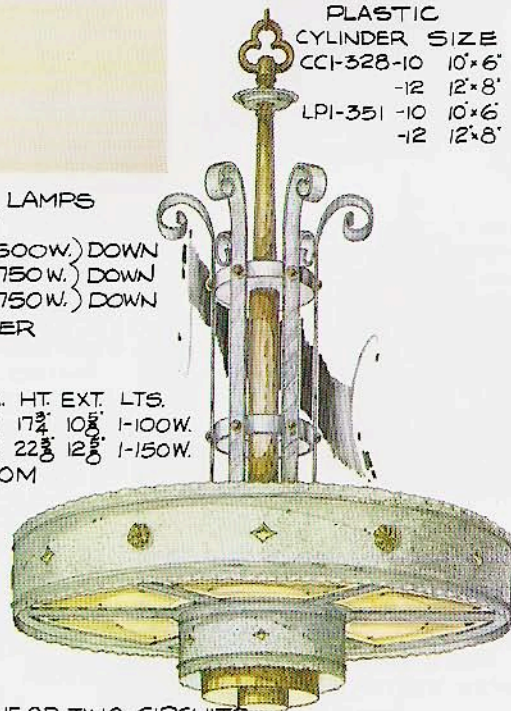

WIRED FOR ONE OR TWO CIRCUITS

NO.	DIA'D'	HT'H'	INTER. LTS.	REFLECTOR LAMPS
CPI-342-24	24"	30¾"	3-(60-100W.)	I-R40(300-500W.) DN.
-30	30"	41½"	6-(60-100W.)	I-R40(300-500W.) DN.
-37	37"	51½"	6-(60-100W.)	I-R52(500-750W.) DN.

MANNING
 TRADITIONAL

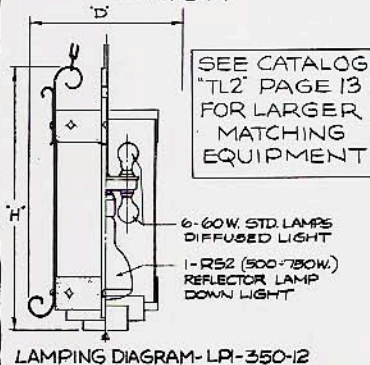

GEORGIAN

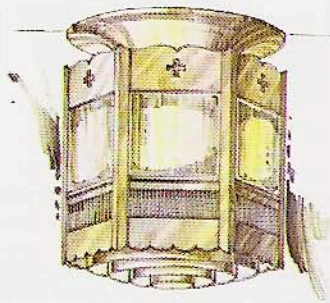

NO.	DIA.	HT.	LTS.
CCI-719-11	11"	13"	3-60W
-13	13"	15"	3-60W



NO.	DIA.	HT. TO LOOP	LTS.
CPI-961-11	11"	28"	4
-13	13"	33"	4

I-R40(150-300W) DOWN LIGHT

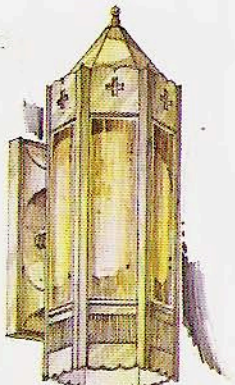

NO.	DIA.	HT.	EXT.	LTS.
LBE-821	8 1/4"	22"	9 3/4"	1-100W

OPEN BOTTOM

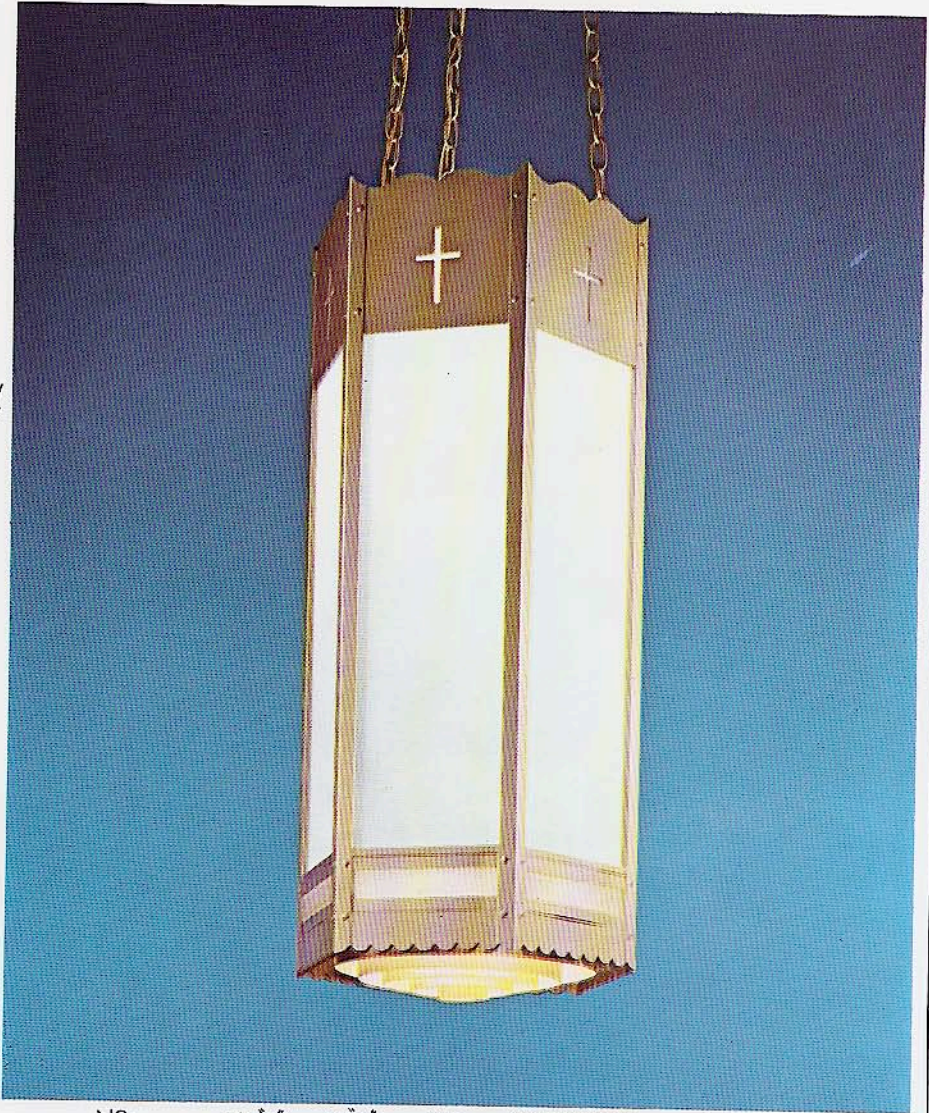

NO.	DIA. D"	HT. H"	LTS.	REFLECTOR	LAMPS
LPI-552-9	9"	19 1/2"	1	- DOWN -	- UP -
-11	11"	21"	4	NONE	NONE
-13	13"	24 1/2"	7	1-R40(150-300W)	NONE
-16	16"	36"	7	1-R40(300-500W)	3-R40(150-300W)
			7	1-R52(500-750W)	3-R40(150-300W)

WIRED FOR ONE, TWO OR THREE CIRCUITS

ENERGY SAVING LAMPING METAL HALIDE DOWNLIGHT
 LPI-552-16ES 16" 36" 7 6-67A21TS 1-MV-400/C/U

SEE CATALOG "TL2" PAGE 14 FOR LARGER MATCHING EQUIPMENT

OPTIONAL FINISHES AND DIFFUSER PANELS PAGE 23

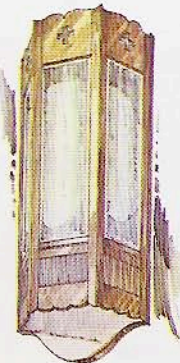

NO.	WD.	HT.	EXT.	LTS.
LBI-698	8 1/4"	20"	4 1/2"	2-100W

OPEN TOP & BOTTOM

MANNING TRADITIONAL

CAST ALUMINUM

COLONIAL

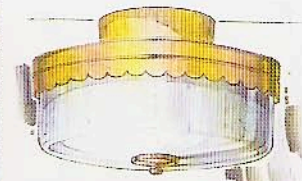

NO. DIA. HT. LTS.
 CC1-518-12R 12 1/4" 8" 3-60W
 -14R 13 3/4" 8" 3-60W
 -16R 16 1/4" 8" 3-60W
 WHITE ACRYLIC PLASTIC BOWL

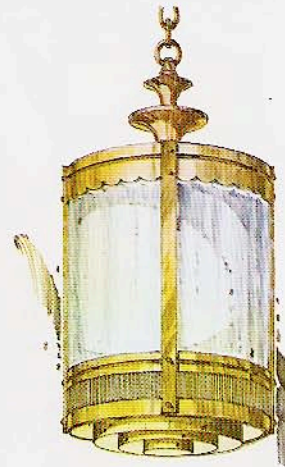

NO. DIA. HT. HT. CYL. SIZE LTS.
 LPI-320-11A 10 1/2" 23" 10" x 12" 4
 -13A 12 1/2" 25 1/2" 12" x 14 1/2" 4
 1-R40(150-300W) DOWNLIGHT

SEE CATALOG
 "TL2" PAGE 15
 FOR LARGER
 MATCHING
 EQUIPMENT

NO.	DIA. D"	HT. H"	CYL. SIZE	LTS.	REFLECTOR	LAMPS
LPI-313-9A	9"	26"	8" x 16"	4	1-R40(150-300W) DOWN	NONE UP
-11A	11"	30 1/2"	10" x 20"	7	1-R40(150-300W) DOWN	3-R30(75W) UP
-13A	13"	32 1/2"	12" x 22"	7	1-R40(300-500W) DOWN	3-R40(150W) UP

FINISH - POLISHED OR SATIN BRASS - WHITE ACRYLIC PLASTIC CYLINDER

ENERGY SAVING LAMPING METAL HALIDE LAMP
 LPI-313-16ES 16" 51" 16" x 36" 7 6-67A2ITS 1-MV-400/C/U



NO. DIA. HT. EXT. LTS.
 LBI-319 7" 20" 4" 1-110-60W
 6" x 20" WHITE ACRYLIC HALF CYL.
 OPEN TOP & BOTTOM

NO. DIA. HT. EXT. LTS.
 LBE-634-10 10" 23" 10 3/4" 1-60W
 -12 12 29 1/2" 14 1/2" 1-100W
 GLASS - CLEAR CRYSTAL

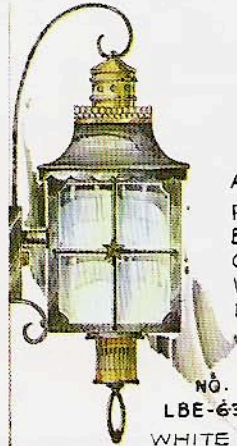
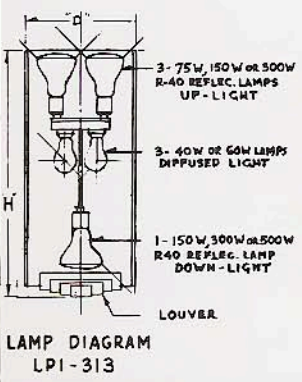

CAST ALUMINUM FINISHES - BAKED BLACK OR WHITE WITH SATIN BRASS TRIM



NO. DIA. HT. EXT. LTS.
 LBE-631 9" 26 1/2" 11 1/2" 1-150W
 WHITE OPAL GLASS PANELS

MANNING
 TRADITIONAL

FOR OUR FULL COLONIAL LINE SEE "AMERICANA" CATALOG "DC"

COLONIAL

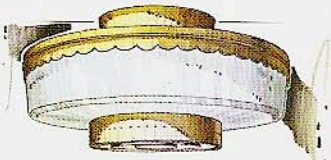

BOWL
 NO. DIA. HT. SIZE LTS.
 CCI-329-14R 14½ 9¼ 14¼ 3-60W
 -16R 16½ 9¼ 16¼ 3-60W
 -18R 18½ 9¼ 18¼ 3-60W
 VIRGIN WHITE ACRYLIC PLASTIC BOWL
 SAME AS ABOVE LESS SCALLOPED
 BAND - ADD SUFFIX -P

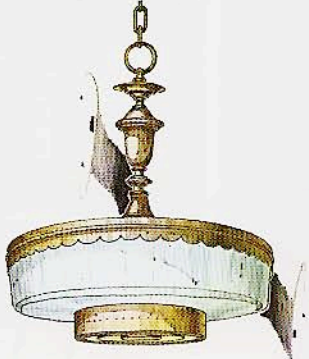

BOWL
 NO. DIA. HT. SIZE LTS.
 CPI-344-14R 14½ 18½ 14¼ 3-60W
 -16R 16½ 18½ 16¼ 3-75W
 -18R 18½ 18½ 18¼ 3-100W
 VIRGIN WHITE ACRYLIC PLASTIC BOWL
 SAME AS ABOVE LESS SCALLOPED
 BAND - ADD SUFFIX -P

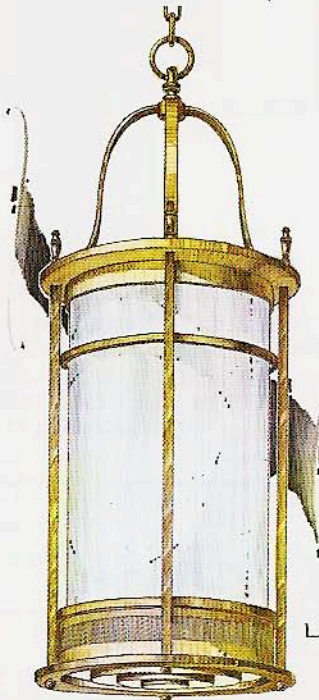

NO. DIA. D' HT. H' BOWL SIZE INTER. LTS. REFLECTOR LAMPS
 CPI-343-24 24½ 28½ 24" x 5½ 6(60-100W.) 1-R40(300-500W.) DOWN
 -30 30½ 28½ 30" x 5½ 6(60-100W.) 1-R40(300-500W.) DOWN
 SAME AS ABOVE LESS SCALLOPED BAND - ADD SUFFIX -P

WIRED FOR ONE OR TWO CIRCUITS
 VIRGIN WHITE ACRYLIC PLASTIC BOWL
 FINISH - NUBRASS

SEE CATALOG
 "TL2 PAGE 16"
 FOR LARGER
 MATCHING
 EQUIPMENT

NO. DIA. HT. EXT. LTS.
 LBI-337 9" 16" 4" 2-60W.
 8" x 16" HALF CYLINDER - WHITE ACRYLIC
 PLASTIC

SAME AS ABOVE LESS SCALLOPED
 BAND - ADD SUFFIX -P
 OPEN TOP AND BOTTOM

NO. DIA. HT. LTS. CYL. SIZE REFLECTOR LAMP
 LPI-312-11 11½ 28" 4" 10" x 18" 1-R40 (150-300W.) DOWN
 -14A 14" 33" 4" 12" x 22" 1-R40 (300-500W.) DOWN
 -18A 18" 51" 7" 16" x 30" 1-R52 (500-750W.) DOWN

FINISHES - POLISHED BRASS OR SATIN BRASS
 WHITE ACRYLIC PLASTIC CYLINDER
 WIRED FOR ONE, TWO OR THREE CIRCUITS

ENERGY SAVING LAMPING METAL HALIDE DOWNLIGHT
 LPI-312-18ES 18" 51" 7" 16" x 30" 6-67A21TS 1-MV-400/C/U

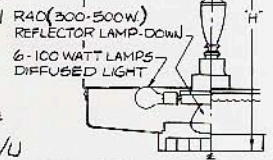

MANNING
 TRADITIONAL

LAMPING DIAGRAM CPI-343-30

Eternalite Traditional

TO MATCH COMPARABLE
SERIES NUMBERS IN
T6 CATALOG

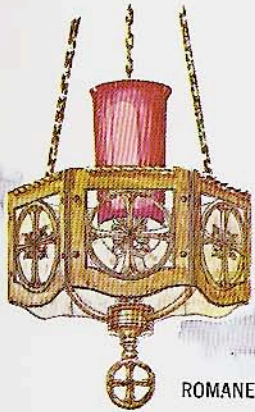

ROMANESQUE

NO. DIA. "D" HT. "H" LTS.
LPI-603E 13" 18" 1-25W
MATCHES LPI-603 SERIES

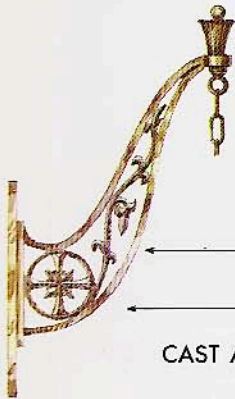

BRACKETS
FOR ABOVE

BR-6 ROMANESQUE
(SHOWN)

BR-5 GOTHIC
(INSERT)

BR-7 COLONIAL
(INSERT)

CAST ALUMINUM

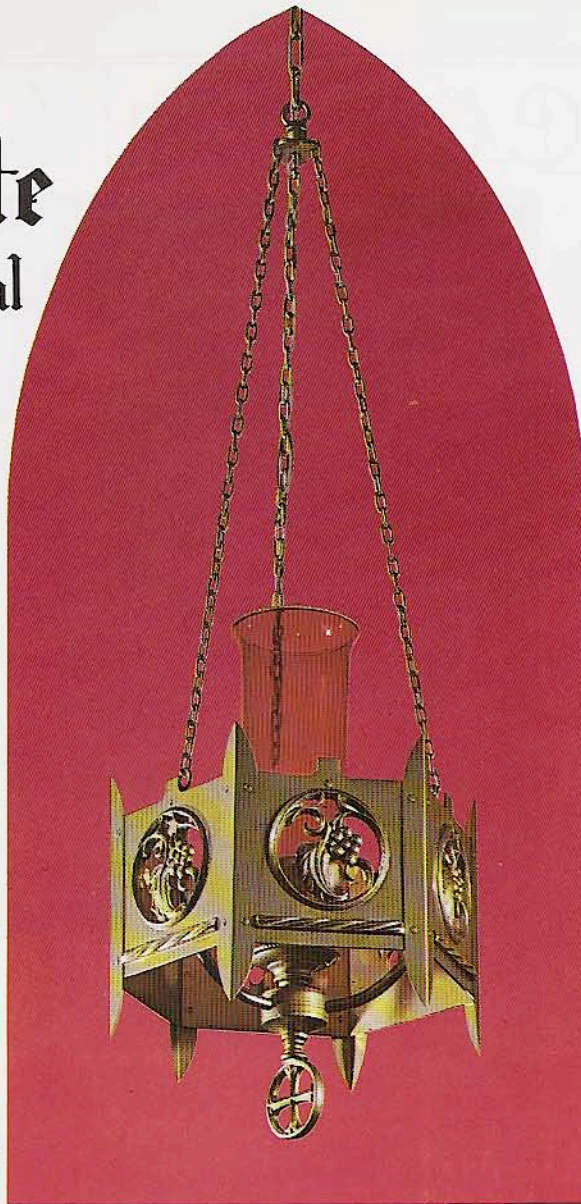

ENGLISH GOTHIC

NO. DIA. "D" HT. "H" LTS.
LPI-577-E 13½" 18" 1-25W

MATCHES LPI-577 SERIES

FINISHES — OPTIONAL PAGE 23
RUBY GLASS SHADE



ROMANESQUE

NO. DIA. HT. LTS.
LPI-311-E 13½" 18" 1-25W
MATCHES LPI-311 SERIES

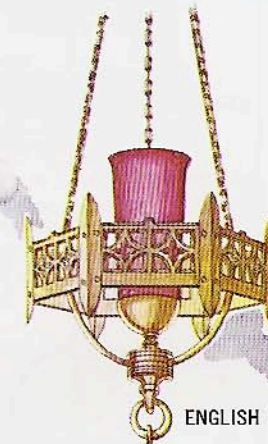

ENGLISH GOTHIC

NO. DIA. "D" HT. "H" LTS.
LPI-660E 13½" 14½" 1-25W

MATCHES LPI-660 SERIES

TO SIMULATE CANDLE OR OIL FLAME
MEDIUM BASE FLICKER LAMPS CAN BE USED
FOR OIL BURNING
ADD LETTER "Z"

ADDITIONAL ETERNALITES CAN BE FURNISHED TO MATCH THE
FOLLOWING SERIES IN T-7 CATALOG BY ADDING SUFFIX "E"
LPI-305 LPI-313 and LPI-552

SEE CONTEMPORARY CATALOG FOR CONTEMPORARY ETERNALITIES

RECESSED INDICATOR LIGHTS FOR CONFESSIONALS, ETC.

FOR CONFESSIONALS CAN BE ACTUATED BY KNEELER
SWITCH (BRYANT #2969 SUPPLIED BY CONTRACTOR)
TO INDICATE OCCUPANCY.

1. CONFESSIONAL KNEELER SWITCH.
2. PRIEST COMPARTMENT LIGHT.
3. CONFESSIONAL INDICATOR LT.
4. PRIEST INDICATOR LIGHT.

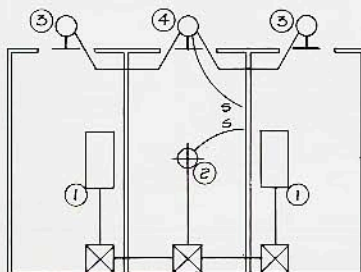

PLAN
CONFESSIONAL LIGHTING DETAIL



RED,
BLUE
OR
GREEN
GLASS
INSERTS



NO. WD. HT. LTS.
CBI-109 2½" 4½" 1-6W
Recessed Switch Box and Lamp Included



NO. WD. HT. LTS.
CBI-110 2½" 4½" 1-6W
Recessed Switch Box and Lamp Included



NO. WD. HT. LTS.
CBI-125 2½" 4½" 1-6W
Recessed Switch Box and Lamp Included



NO. WD. HT. LTS.
CBI-126 2½" 4½" 1-6W
Recessed Switch Box and Lamp Included

STANDARD FINISHES SATIN GOLD OR NATURAL BRONZE

MANNING
TRADITIONAL

Spatialite - CORNER

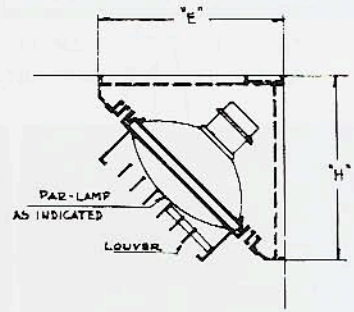
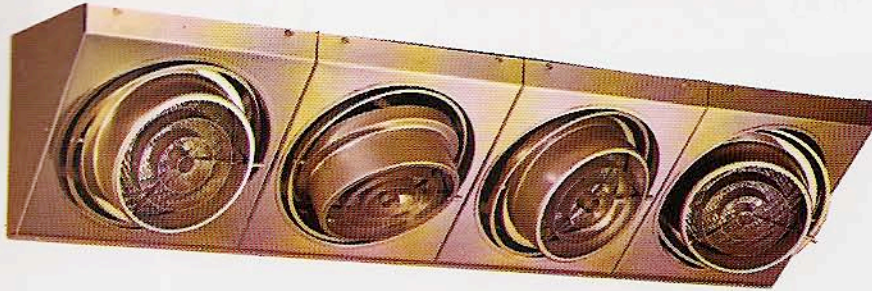

CROSS SECTIONS
GC-46 AND GC-64 UNITS

FOR ENCLOSED BACK
ADD SUFFIX A TO
THE NUMBER
I.E., GC-(No.)A

**FULLY ADJUSTABLE LOUVERED GIMBAL RING UNITS FOR VERTICAL OR HORIZONTAL INSTALLATION
LISTED BY UNDERWRITERS LABORATORIES FOR SURFACE MOUNTING NOT FOR APEX MOUNTING**

FOR MOUNTING BEHIND BEAMS OR ARCHES FOR GENERAL NAVE FLOODLIGHTING USING MEDIUM OR WIDE FLOOD PAR LAMPS OR FOR SPOTLIGHTING PULPITS, LECTERNS, ALTARS, SHRINES OR STATIONS USING PAR SPOT LAMPS.

FLOOD LAMPS & SPOT LAMPS CAN BE COMBINED IN ONE UNIT
TO SERVE A DUAL PURPOSE OF FLOOD & SPOT LIGHTING

TWIN GIMBAL RINGS PERMIT LAMP TO BE TILTED IN EITHER DIRECTION 45°

ON FOLLOWING UNITS 150W AND 200W LAMPS CAN BE USED IN SAME UNIT BY USING GA-38 ADAPTORS FOR 150W SIZE

NO.	HT. "H"	EXT. "E"	LENGTH "L"	LAMP CENTERS	LTS.	LAMP WATTAGE	LAMP NO.	TYPE
GC-146	8"	8"	10"		1	200W	200 PAR 46/3NSP 200 PAR 46/3MFL	SPOT OR MEDIUM FLOOD
GC-246	8"	8"	19"	9"	2	200W		"
GC-346	8"	8"	28"	9"	3	200W		"
GC-446	8"	8"	37"	9"	4	200W		"

ON FOLLOWING UNITS 300W AND 500W LAMPS CAN BE USED IN SAME UNIT BY USING GA-56 ADAPTORS FOR 300W SIZE AND 500W PAR Q LAMPS

GC-164	10"	10"	12½"		1	*300W *300W *300W	300 PAR 56/NSP 300 PAR 56/MFL 300 PAR 56/WFL OR 500 PAR 64/NSP 500 PAR 64/MFL 500 PAR 64/WFL	SPOT OR MEDIUM FLOOD OR WIDE FLOOD
		STANDARD FINISH - NATURAL BRONZE						
		SPECIAL FINISHES AVAILABLE						
GC-264	10"	10"	24½"	12"	2	*300-500W		"
GC-364	10"	10"	36½"	12"	3	*300-500W		"
GC-464	10"	10"	48½"	12"	4	*300-500W		"

ADAPTOR RINGS

*GA-56 FOR PAR 56-300W IN -64 SERIES
GA-46 FOR PAR 46-200W IN -64 SERIES
GA-64/38 FOR PAR 38-150W IN -64 SERIES
GA-38 FOR PAR 38-150W IN -46 SERIES - (PRONG BASE)
AT EXTRA COST - SEE PRICE LIST

COLOR FILTERS

IN AMBER, PINK, RED, BLUE, GREEN AND WHITE
AVAILABLE - SEE PRICE LIST
ALL UNITS FURNISHED LESS LAMPS

FOR ENCLOSED BACK ON
ABOVE UNITS ADD SUFFIX "A"
I.E., GC-(No.)A
FLUSH BACK PLATE
FOR EXPOSED MOUNTING



NO.	HT. "H"	EXT. "E"	LENGTH "L"	LAMP CENTERS	LTS.	LAMP WATTAGE	LAMP NO.	TYPE
GCQ-164	8"	8"	10"		1	500W to 1000W	Q-500 PAR 56 to Q-1000 PAR 64	NSP, MFL, or WFL
GCQ-264	8"	8"	19"	9"	2	500W to 1000W	Q-500 PAR 56 to Q-1000 PAR 64	NSP, MFL, or WFL
GCQ-364	8"	8"	28"	9"	3	500W to 1000W	Q-500 PAR 56 to Q-1000 PAR 64	NSP, MFL, or WFL
GCQ-464	8"	8"	37"	9"	4	500W to 1000W	Q-500 PAR 56 to Q-1000 PAR 64	NSP, MFL, or WFL

ALL UNITS FURNISHED WITH PROTECTIVE SCREENS
INSTEAD OF LOUVERS

GA-56 ADAPTOR RINGS REQUIRED WHEN USING Q500W PAR 56

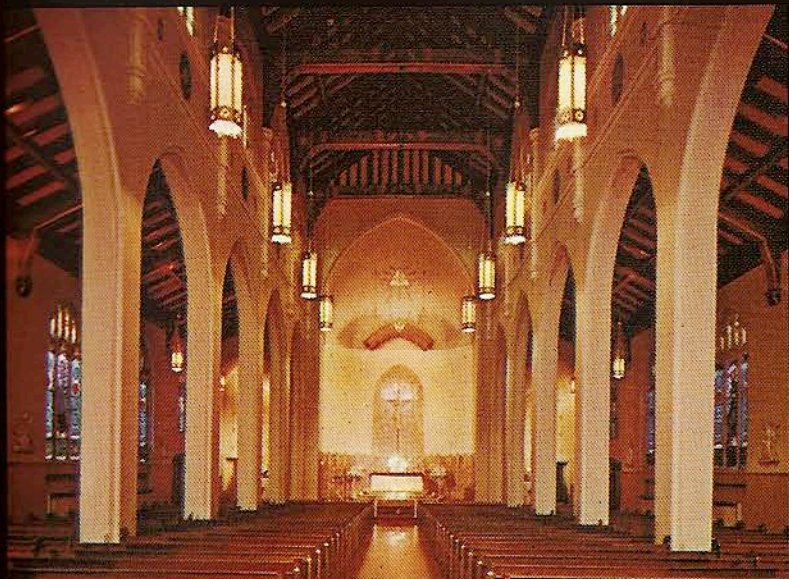

A tradition of quality.

Manning Lighting has been illuminating churches and other religious buildings since 1948. Each fixture is manufactured by expert craftspeople and built to your specifications.

For matching equipment for other interior and exterior locations, please see our Traditional Church Lighting Catalog for Large Interiors. Contemporary and Colonial Church Lighting catalogs also available.



1810 North Ave., P.O. Box 1063,
Sheboygan, WI 53082
Phone: 920-458-2184 Fax: 920-458-2491
Email: Info@ManningLtg.com
Website: www.manningltg.com